



light+building



2023
WINNER
LIGHTING
DESIGN
AWARDS

Katalog produktów / Product Catalogue
2024



Trzymasz w ręku nowy katalog **LUMINES Lighting** na lata 2023/24.

Przez ostatnie miesiące pracowaliśmy nad udoskonalaniem dotychczasowych systemów oraz projektami nowych produktów, będących odpowiedzią na potrzeby płynące z rynku.

Myśląc o swojej działalności jak o misji, tworzyliśmy rozwiązania, które znacząco wpłyną na proces projektowania oświetlenia liniowego.

Naszym celem jest wspieranie projektantów i instalatorów poprzez kompleksowe rozwiązania, od dobrze zaprojektowanych produktów, po narzędzia usprawniające proces tworzenia.

Konfigurator 3D, tworzony przez zespół **Lumines Lighting**, otwiera nowe możliwości, dając twórcom oświetlenia wpływ na kształt finalnej oprawy LED.

Wierzymy w to co robimy i mamy nadzieję, że razem z nami odkryjesz magię tworzenia projektów z wykorzystaniem profili LED.

Cieszymy się, że jesteś z nami.

zespół **Lumines Lighting**

You are holding the new **LUMINES Lighting** catalog for 2023/24 in your hand.

Over the last few months, we have been working on improving existing systems and designing new products in response to market needs.

Thinking about our business as a mission, we created solutions that will significantly influence the linear lighting design process.















Our goal is to support designers and installers with comprehensive solutions, from well-designed products to tools that improve the creation process.

The 3D configurator, created by the **Lumines Lighting** team, opens up new possibilities, giving lighting creators an influence on the shape of the final LED fixture.



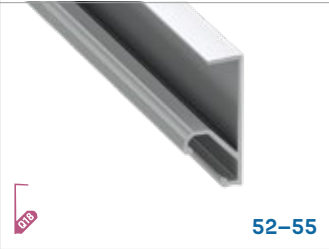







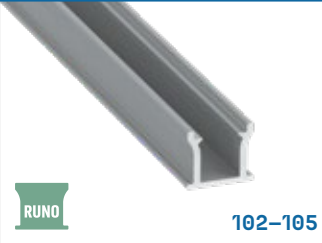

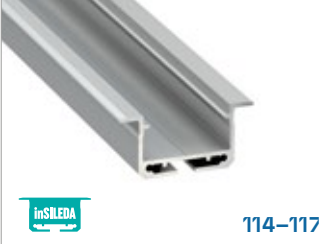



We believe in what we do and we hope that with us you will discover the magic of creating projects using LED profiles.

We're glad you're with us.

team **Lumines Lighting**

<p>NOWE profile 2023 NEW profiles 2023</p>		 <p>U 56-59</p>	 <p>GEM1 80-83</p>
 <p>FALCO 186-189</p>	 <p>PLATO 190-193</p>	 <p>BAUDI 194-197</p>	 <p>HIRO 198-201</p>
<p>profile meblowe 16-97 furniture profiles</p>		 <p>A 16-19</p>	 <p>B 20-23</p>
	 <p>C 24-27</p>		
 <p>D 28-31</p>	 <p>E 32-35</p>	 <p>F 32-35</p>	 <p>G 36-39</p>
 <p>J 40-43</p>	 <p>H 44-47</p>	 <p>I6 48-51</p>	 <p>I10 48-51</p>
 <p>I15 52-55</p>	 <p>I20 52-55</p>	 <p>U 56-59</p>	 <p>W 60-63</p>
 <p>X 64-67</p>	 <p>Y 68-71</p>	 <p>Z 72-75</p>	 <p>DUAL 76-79</p>
 <p>GEM1 80-83</p>	 <p>MICO 84-87</p>	 <p>COSMO 88-93</p>	 <p>RETO 94-97</p>

profile architektoniczne
98-239
architectural profiles

		 TERRA 98-101	 RUNO 102-105
 SCALA 106-109	 SILEDA 110-113	 inSILEDA 114-117	 DILEDA 118-121
 INDLEDA 122-125	 UNICO 126-129	 DOPIO 130-133	 SOLIS 134-137
 ILEDO 138-141	 INSO 142-145	 TALIA 154-165	 ITALIA 166-169
 NEW 2023 FALCO 186-189	 NEW 2023 PLATO 190-193	 NEW 2023 GAUDI 194-197	 NEW 2023 HERO 198-201
 MONO 202-205	 ZATI 206-209	 SUBLI 210-213	 APA 12 226-229
 APA 16 226-229	 IPA 12 226-229	 IPA 16 226-229	

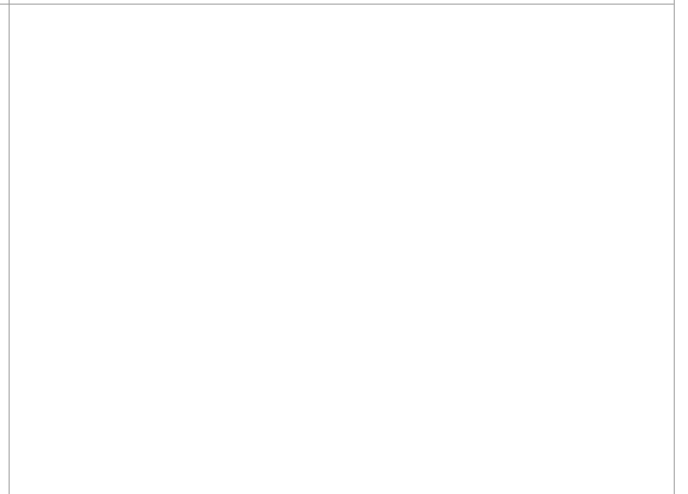

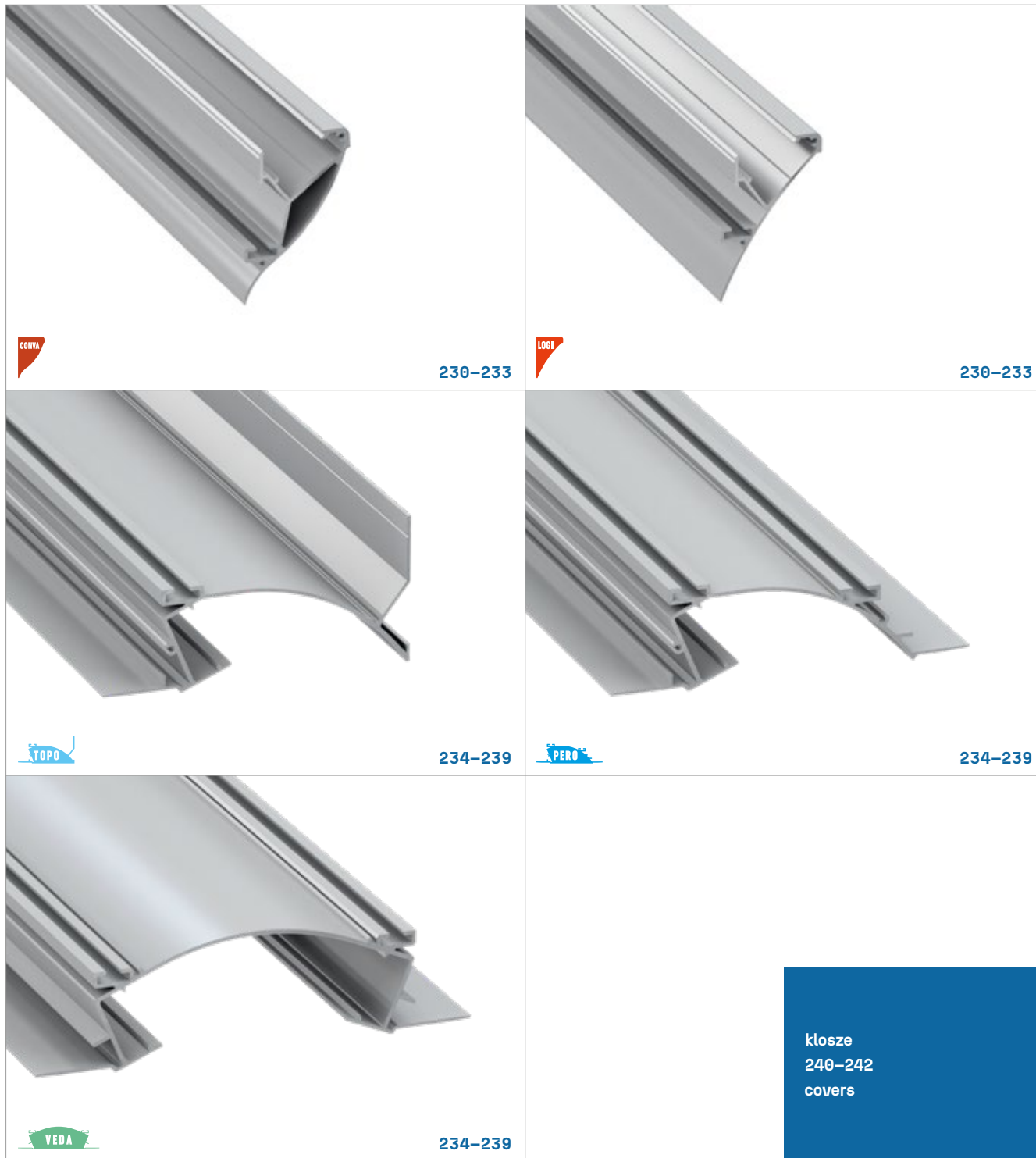

Symbole dotyczące montażu użyte w katalogu / Symbols for assembly used in the catalogue:

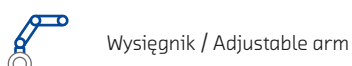
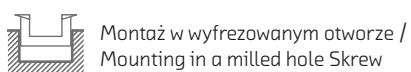
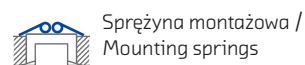
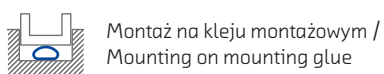
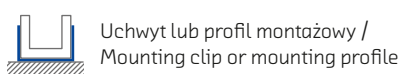
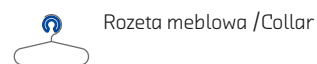

Szerokość / Width [mm]	Ilość taśm LED / Number of LED strips	Profil wpuszczany / Recessed profile	Profil powierzchniowy / Surface profile	Montaż w gipsie / Installation in plaster	Kątowe / Corner profiles	Szybowe / Nabijane na płytę / Glass edge profiles / Furniture shelf edge profiles	Okrągłe / Round profiles	Schodowe / Stair nosing profiles	Montażowe / Mounting profiles
12,0	1		X (64-67)						
13,0	1					APA12 (226-229) IPA12 (226-229)			
16,0	1	B (20-23)	A (16-19) D (28-31) Z (72-75)		C (26-29) H (46-49)	IPA16 (226-229) APA16 (226-229)	MICO (84-87)		
16,7	1		F (34-37)			I6 (50-53)			
17,0	1	G (38-41) J (42-45) W (62-65)	Y (70-73)						
18,2	1					Q18 (52-55)			
18,8	1					I10 (48-51)			
19,4	1		E (32-35)						
20,0	1		TERRA (98-101) RUNO (102-105)						
20,2	1					Q20 (52-55)			
23,3	1			MONO (202-205)					
24,0	1	U (56-59)							
25,0	1						COSMO (88-93)		
27,4	2		DUAL (76-79)						
27,4	2	inSILEDA (114-117) inDILEDA (122-125)	SILEDA (110-113) DILEDA (118-121)	SUBLI (210-213)					
34,0	2			ZATI (206-209)					
35,2	2	GEMI (80-83)							
36,0	2	inTALIA (166-169)	UNICO (126-129) TALIA (154-165)						TALIA M1 (158) TALIA M2 (159)
40,0	2			FALCO (186-189)					
41,8	2			GAUDI (194-197)					
43,0	3	INSO (142-145)	DOPIO (130-133) SOLIS (134-137) ILEDO (138-141) CLARO (146-149) DULIO (150-153)						
51,6	2			PLATO (190-193)					
52,3	1	TIANO (218-221)							
54,9	3		RETO (94-97)						TALIA M3 (160)
57,4	3			HIRO (198-201)					
63,0	2		CONVA (230-233) LOGI (230-233)						
65,3	1	FLARO (222-225)							
72,0	4							SCALA (106-109)	TALIA M4 (161)
85,4	2	TOPO (234-239)							LARGO M3 (176) LARGO M4 (177)
85,4	2	PERO (234-239)							
87,6	6-8	SORGA (214-217)							
88,0	6-8	inLARGO (182-185)	LARGO (170-181)						LARGO M1 (174) LARGO M2 (175)
112,6	4	VEDA (234-239)							

Przewodnik inspiracji

Inspiration guide

PL

Zapraszamy Cię do obejrzenia kilku naszych inspirujących wnętrz. Pokażemy Ci, jak możesz wykorzystać nasze produkty, aby Twoja przestrzeń dawała Ci najlepsze światło.

EN

We invite you to see a dozen of our inspiring interiors. We will show you how you can use our products so that your space gives you the best light.



LUMINES[®]
LIGHTING



Kuchnia

Kitchen

PL

W tej przestrzeni wykorzystaliśmy dwa nasze profile: profil nawierzchniowy DUAL oraz profil kątowy H. Ich połączenie pozwoliło na dyskretne rozłożenie akcentów i podkreślenie najbardziej charakterystycznych linii wnętrza.

EN

In this space, we used several of our profiles: the DUAL surface profile and the H corner profile. The combination of these two profiles allowed for a discreet arrangement of accents and emphasizing the most characteristic lines of the interior.



Jadalnia

Dining room

PL

Oświetlenie części jadalnianej to ważny element tego pomieszczenia. Poza funkcjonalnością, warto zwrócić uwagę na element dekoracyjny. W tym pomieszczeniu, zastosowaliśmy profil wpuszczany SUBLI, wąski profil wpuszczany G oraz oprawę LED wykonaną z profilu CLARO.

EN

Dining room lighting is an important element of the decor of this room. Apart from functionality, it is good to think about the decorative aspect. In this room we used: SUBLI plaster-in recessed profile, G recessed profile and CLARO luminaire. The CLARO lamp illuminates the dining area of the room, while the recessed profiles play a decorative role.



Łazienka

Bathroom

PL

W tej łazience wykorzystaliśmy podłogowy profil RUNO oraz nawierzchniowy profil SILED. Profile dyskretnie wyznaczają strefy w łazience, wprowadzając elementy dekoracyjne w postaci subtelnych linii światła.

EN

In the bathroom, we used: the RUNO recessed profile and the inSILED profile. Profiles discreetly delineate zones in the bathroom introducing decorative elements in the form of a subtle line of light in the floor and ceiling.



Gabinet

Office

PL

Delikatnie zarysowana linia sufitu, subtelne linie schodów, odpowiednie oświetlenie biurka. Warto takie detale planować na etapie projektu. Dobrze wyważone światło sprawi, że chętnie będziemy pracować i nie będziemy obciążać wzroku. W tym pomieszczeniu wykorzystaliśmy profile: SOLIS jako lampę, profil A umieszczony na schodach oraz profil ZATI w suficie.

EN

A delicately marked line of the ceiling, subtle lines of stairs, adequate lighting of the desk. It is worth planning such details at the design stage. Well-balanced light will encourage us to work and will not tire our eyesight. In this room we used profiles: SOLIS as a lamp, profile A placed on the stairs and profile ZATI in the ceiling.



Korytaż

Corridor

PL

Profile LED zastosowane w korytarzu pełnią nie tylko funkcję wystroju wnętrza, ale również komunikacyjną. Światło wydobywające się z profilu tworzy surową i ostrą linię. Rozwiązanie to podkreśla nowoczesny, minimalistyczny wystrój wnętrza.

EN

LED profiles used in the corridor serve not only an interior design function, but also a communication function. The light emanating from the profile creates a raw and sharp line. This solution highlights the modern, minimalist decor interiors.



Salon

Living room

PL

Oświetlenie przypodłogowe w formie surowych linii światła pozwala na wyraźne zarysowanie stref komunikacyjnych lub spójny połączenie różnych przestrzeni domu.

EN

Floor lighting in the form of raw lines of light allows for clear outlines of communication zones or a coherent connection between various spaces of the house.



A

Profil LED / Profile LED

PL

Profil nawierzchniowy – do podświetlenia dekoracyjnego pomieszczeń biurowych oraz domowych.

EN

Surface-mounted – for decorative lighting in offices and homes.

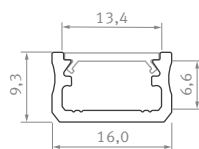

A

Sposoby montażu /
Assembly methods

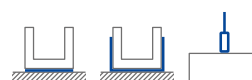





A

A

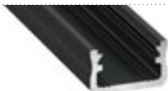

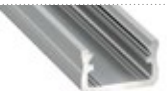







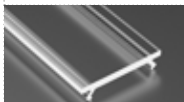

Profil LED / Profile LED

Wymiary [mm] / Dimensions (mm): 1000, 2020, 3000

















	BIAŁY (lakierowany) white (lacquered)	CZARNY (anodowany) black (anodized)	INOX (anodowany) inox (anodized)	SREBRNY (anodowany) silver (anodized)	SUROWY raw
Kolory profili Profile colors					
1,0 m	10-0011-10	10-0012-10	10-0013-10	10-0014-10	10-0010-10
2,02 m	10-0011-20	10-0012-20	10-0013-20	10-0014-20	10-0010-20
3,0 m	10-0011-30	10-0012-30	10-0013-30	10-0014-30	10-0010-30
Szerokość taśmy LED (mm) LED strip width (mm)	do 12 up to 12				

Klosze (PVC/PMMA/PC) / Covers

Wymiary [mm] / Dimensions (mm): 1000, 2020, 3000

TRANSPARENTNY transparent	MROŻONY frozen	MLECZNY milky	FROSTED MLECZNY milky frosted	CZARNY PMMA black PMMA	LENS 15 lens 15	LENS 30 lens 30
BASIC						
						
1 m/PMMA 11-2350-10 1 m/PC 11-3013-10	1 m/PMMA 11-2302-10 1 m/PC 11-3012-10	1 m/PMMA 11-2251-10 1 m/PC 11-3011-10	1 m/PMMA 11-2406-10	1 m/PMMA 11-2017-10	1 m/PMMA 11-2060-10	1 m/PMMA 11-2080-10
HIGH						
						
1 m/PMMA 11-2053-10	1 m/PMMA 11-2052-10	1 m/PMMA 11-2051-10	1 m/PMMA 11-2056-10	1 m/PMMA 11-2057-10		

Zaślepki (aluminium i tworzywo sztuczne) / End caps (aluminum and plastic)

Z OTWOREM with a hole				BEZ OTWORU without a hole			
BIAŁY white	CZARNY black	INOX inox	SREBRNY / SZARY silver / gray	BIAŁY white	CZARNY black	INOX inox	SREBRNY / SZARY silver / gray
BASIC							
							
ABS 12-0011-00	ALU 12-0012-10 ABS 12-0012-00	ABS 12-0013-00	ALU 12-0015-10 ABS lacq. 12-0000-34 ABS 12-0014-00	ABS 12-0011-01	ABS 12-0012-01	ABS 12-0013-01	ALU 12-0015-11 ABS lacq. 12-0000-20 ABS 12-0014-01
HIGH							
							
ABS 12-0021-00	ALU 12-0022-10 ABS 12-0022-00	ABS 12-0023-00	ALU 12-0025-10 ABS lacq. 12-0000-34 ABS 12-0024-00	ABS 12-0021-01	ABS 12-0022-01	ABS 12-0023-01	ALU 12-0025-11 ABS lacq. 12-0000-33 ABS 12-0024-01

Dodatki / Accessories

TRANSPARENTNY, BIAŁY, CZARNY transparent, white, black								
UCHWYT A MINI mounting clip A MINI	UCHWYT A mounting clip A	UCHWYT A HIGH mounting clip A HIGH	UCHWYT A METALOWY metal mounting clip A	UCHWYT A KĄTOWY angled mounting clip A	ZAWIAS hinge	WŁĄCZNIK BEZDOTYKOWY contactless switch	UCHWYT NA PRZEWÓD 5 mm cable fi 5 mm holder	ZAWIESIA pendants
								
13-0023-00	13-0013-00	13-0033-00	13-0110-02	13-0093-00	14-6045-00	14-7052-00	*T 14-7067-00 *B 14-7067-02	*S 14-2011-02 *B 14-2076-00 *W 14-2075-00

* S SREBRNY silver; * B CZARNY black; * T TRANSPARENTNY transparent; * W BIAŁY white



A
LUMINES

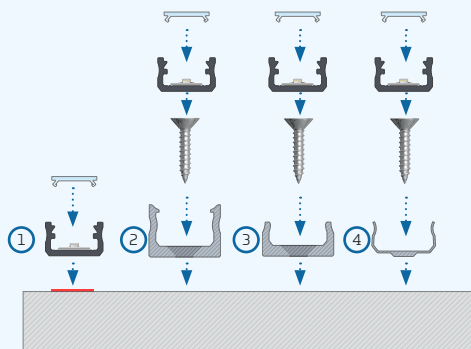

PL
Instrukcja montażu profilu A z kloszem BASIC, [1] z taśmą dwustronną, [2] z uchwytem montażowym A, [3] z uchwytem A MINI, [4] z uchwytem metalowym A.

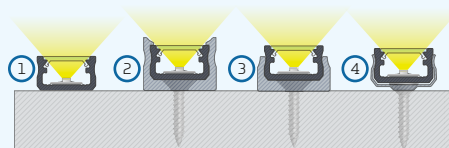

EN
Installation manual for A profile with BASIC cover, [1] with double-sided tape, [2] with a mounting clip for A, [3] with A MINI mounting clip, [4] with metal mounting clip A.

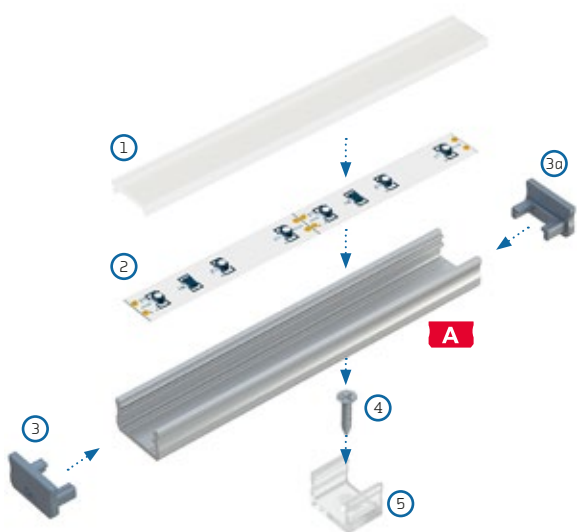

PL
Schemat złożenia elementów systemu oświetleniowego z wykorzystaniem profilu A oraz [1] klosza BASIC, [2] taśmy LED, [3] zaśleпки z otworem, [3a] zaśleпки bez otworu, [4] wkrętu montażowego, [5] uchwytem montażowym A MINI.

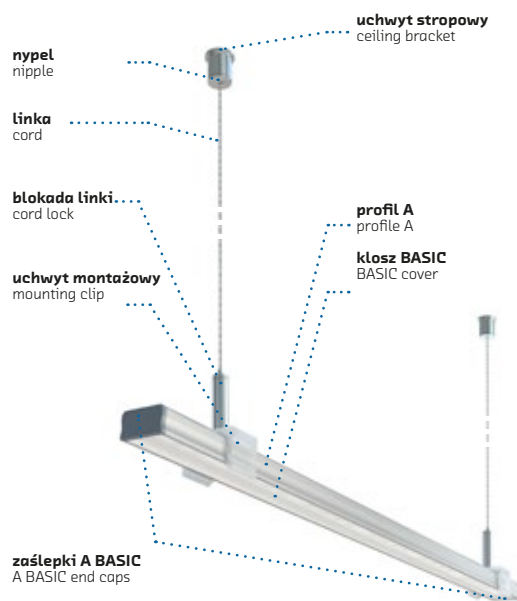

EN
Assembly scheme for elements of the lighting system using a profile A and [1] a BASIC cover, [2] a LED strip, [3] an end cap with hole, [3a] an end cap without hole, [4] a mounting screw, [5] a MINI mounting clip for profile A.

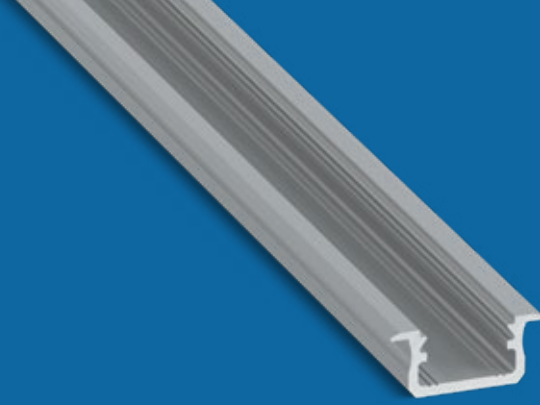

B

Profil LED / Profile LED

PL

Profil wpuszczany – do oświetlenia pomieszczeń kuchennych, sklepowych
– oświetlenie półek, blatów.

EN

Groove mounted profile – for lighting kitchens and stores – lighting for
shelves, countertops.

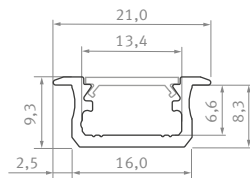

Sposoby montażu /
Assembly methods





B

B





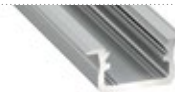
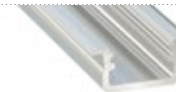

Profil LED / Profile LED

Wymiary [mm] / Dimensions (mm): 1000, 2020, 3000









	BIAŁY (lakierowany) white (lacquered)	CZARNY (anodowany) black (anodized)	INOX (anodowany) inox (anodized)	SREBRNY (anodowany) silver (anodized)	SUROWY raw
Kolory profili Profile colors					
1,0 m	10-0021-10	10-0022-10	10-0023-10	10-0024-10	10-0020-10
2,02 m	10-0021-20	10-0022-20	10-0023-20	10-0024-20	10-0020-20
3,0 m	10-0021-30	10-0022-30	10-0023-30	10-0024-30	10-0020-30
Szerokość taśmy LED (mm) LED strip width (mm)	do 12 up to 12				

Klosze (PVC/PMMA/PC) / Covers

Wymiary [mm] / Dimensions (mm): 1000, 2020, 3000

TRANSPARENTNY transparent	MROŻONY frozen	MLECZNY milky	FROSTED MLECZNY milky frosted	CZARNY PMMA black PMMA	LENS 15 lens 15	LENS 30 lens 30
BASIC						
						
1 m/PMMA 11-2350-10	1 m/PMMA 11-2302-10	1 m/PMMA 11-2251-10	1 m/PMMA 11-2406-10	1 m/PMMA 11-2017-10	1 m/PMMA 11-2060-10	1 m/PMMA 11-2080-10
1 m/PC 11-3013-10	1 m/PC 11-3012-10	1 m/PC 11-3011-10				

Zaślepki (aluminium i tworzywo sztuczne) / End caps (aluminum and plastic)

WYKOŃCZENIE PŁASKIE flat finish				WYKOŃCZENIE OKRĄGLE round finish			
BIAŁY white	CZARNY black	INOX inox	SREBRNY / SZARY silver / gray	BIAŁY white	CZARNY black	INOX inox	SREBRNY / SZARY silver / gray
BASIC							
							
ABS 12-0151-00	ABS 12-0152-00	ABS 12-0153-00	ABS lacq. 12-0000-35 ABS 12-0154-00	ABS 12-0031-00	ALU 12-0032-10 ABS 12-0032-00	ABS 12-0033-00	ALU 12-0035-10 ABS lacq. 12-0000-36 ABS 12-0034-00

Dodatki / Accessories

WŁĄCZNIK BEZDOTYKOWY
contactless switch



14-7052-00



B
LUMINES

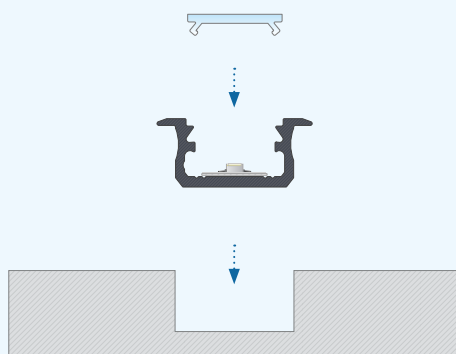

PL
Instrukcja montażu profilu B wpuszczanego z kloszem BASIC.

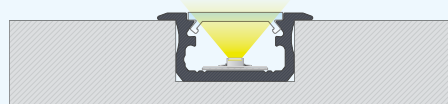

EN
Installation instructions for recessed profile B with a BASIC cover.

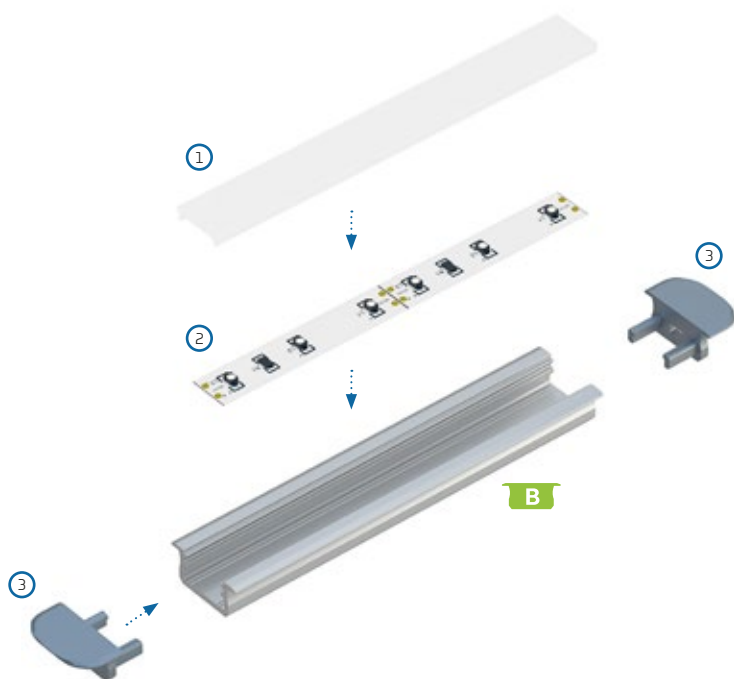

PL
Schemat złożenia elementów systemu oświetleniowego z wykorzystaniem profilu B oraz (1) klosza BASIC, (2) taśmy LED, (3) zaślepek z wykończeniem okrągłym z otworami.

EN
Assembly scheme for elements of the lighting system using profile B and (1) a BASIC cover, (2) a LED strip, (3) rounded caps with hole.

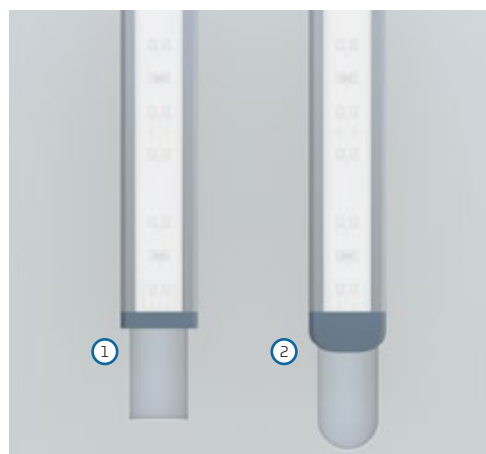

PL
Montaż profilu B wewnątrz wyfrezowanego otworu (1) z zaślepką płaską, (2) z zaślepką okrągłą.

EN
Installation of profile B inside a milled groove (1) with flat end cap, (2) with round end cap.



C

Profil LED / Profile LED

PL
Profil kątowny 45° – do oświetlenia pomieszczeń kuchennych, sklepowych – oświetlenie szaf, blatów.

EN
Angle profile 45 degrees – for lighting kitchens and stores – lighting for shelves, countertops.

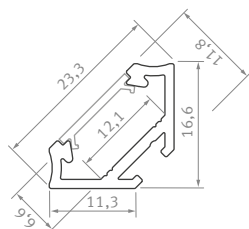

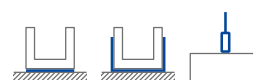

Sposoby montażu /
Assembly methods



C





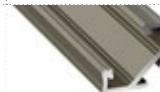
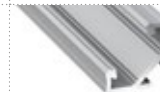
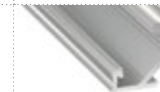

Profil LED / Profile LED

Wymiary [mm] / Dimensions (mm): 1000, 2020, 3000

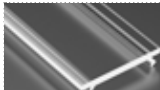



	BIAŁY (lakierowany) white (lacquered)	CZARNY (anodowany) black (anodized)	INOX (anodowany) inox (anodized)	SREBRNY (anodowany) silver (anodized)	SUROWY raw
Kolory profili Profile colors					
1,0 m	10-0031-10	10-0032-10	10-0033-10	10-0034-10	10-0030-10
2,02 m	10-0031-20	10-0032-20	10-0033-20	10-0034-20	10-0030-20
3,0 m	10-0031-30	10-0032-30	10-0033-30	10-0034-30	10-0030-30
Szerokość taśmy LED (mm) LED strip width (mm)	do 12 up to 12				

Klosze (PVC/PMMA/PC) / Covers

Wymiary [mm] / Dimensions (mm): 1000, 2020, 3000

TRANSPARENTNY transparent	MROŻONY frozen	MLECZNY milky	FROSTED MLECZNY milky frosted	CZARNY PMMA black PMMA	LENS 15 lens 15	LENS 30 lens 30
BASIC						
						
1 m/PMMA 11-2350-10 1 m/PC 11-3013-10	1 m/PMMA 11-2302-10 1 m/PC 11-3012-10	1 m/PMMA 11-2251-10 1 m/PC 11-3011-10	1 m/PMMA 11-2406-10	1 m/PMMA 11-2017-10	1 m/PMMA 11-2060-10	1 m/PMMA 11-2080-10

Zaślepki (aluminium i tworzywo sztuczne) / End caps (aluminum and plastic)

Z OTWOREM with a hole				BEZ OTWORU without a hole			
BIAŁY white	CZARNY black	INOX inox	SREBRNY / SZARY silver / gray	BIAŁY white	CZARNY black	INOX inox	SREBRNY / SZARY silver / gray
BASIC							
							
ABS 12-0041-00	ALU 12-0042-10 ABS 12-0042-00	ABS 12-0043-00	ALU 12-0045-10 ABS lacq. 12-0000-38 ABS 12-0044-00	ABS 12-0041-01	ALU 12-0042-11 ABS 12-0042-01	ABS 12-0043-01	ALU 12-0045-11 ABS lacq. 12-0000-37 ABS 12-0044-01

Dodatki / Accessories

TRANSPARENTNY, BIAŁY, CZARNY transparent, white, black						
UCHWYT CH mounting clip CH	UCHWYT CH METALOWY metal mounting clip CH	UCHWYT CH KĄTOWY angled mounting clip CH	ZAWIAS hinge	WŁĄCZNIK BEZDOTYKOWY contactless switch	UCHWYT NA PRZEWÓD fi 5 mm cable fi 5 mm holder	ZAWIESIA pendants
						
13-0043-00	13-0120-02	13-0103-00	14-6045-00	14-7052-00	*T 14-7067-00 *B 14-7067-02	*S 14-2011-02 *B 14-2076-00 *W 14-2075-00

* S SREBRNY silver; * B CZARNY black; * T TRANSPARENTNY transparent; * W BIAŁY white



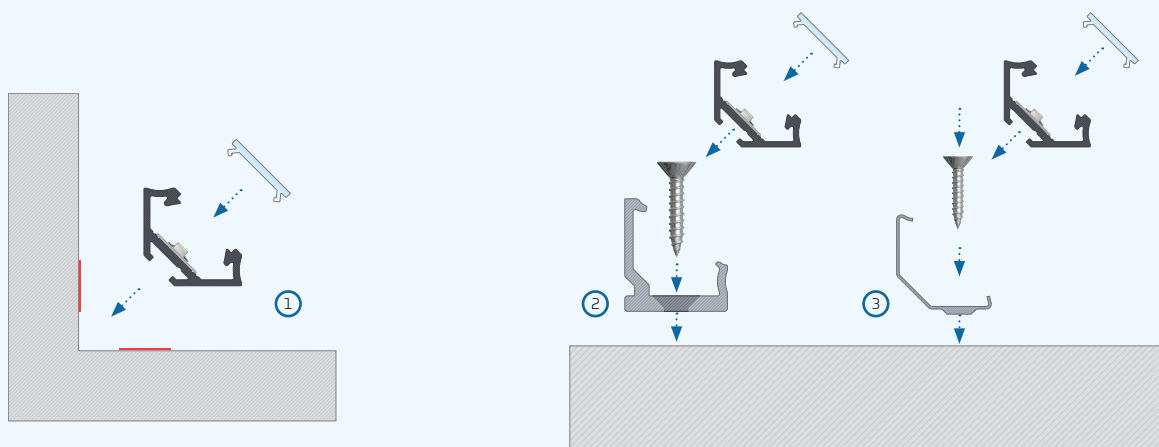

PL

Instrukcja montażu profilu C kątownego z kloszem BASIC za pomocą (1) taśmy dwustronnej, (2) uchwyty montażowego CH z tworzywa, (3) uchwyty montażowego metalowego CH.

EN

Installation manual for C profile with BASIC cover, using (1) double-sided tape, (2) plastic mounting clip CH, (3) metal mounting clip CH.

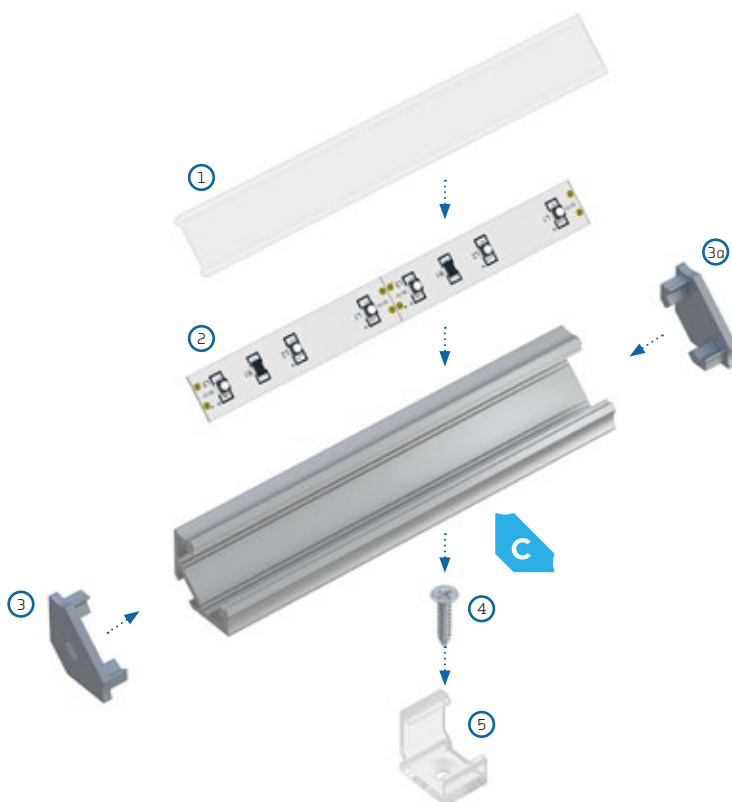

PL

Schemat złożenia elementów systemu oświetleniowego z wykorzystaniem profilu C kątownego oraz (1) klosza BASIC, (2) taśmy LED, (3) zaślepki z otworem, (3a) zaślepki bez otworu (4) wkrętu montażowego, (5) uchwyty montażowego CH.

EN

Assembly scheme for elements of the lighting system using profile C and (1) a BASIC cover, (2) a LED strip, (3) an end cap with hole, (3a) an end cap without hole, (4) a screw, (5) a mounting clip CH.

D

Profil LED / Profile LED

PL
Profil nawierzchniowy – do oświetlenia pomieszczeń kuchennych, sklepowych – oświetlenie szaf, blatów, schodów.

EN
Surface-mounted profile – for lighting kitchens and stores – lighting for shelves, countertops, stairs.

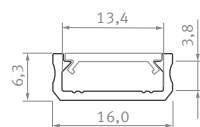

D

Sposoby montażu / Assembly methods

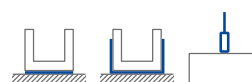





D

D











Profil LED / Profile LED

Wymiary [mm] / Dimensions (mm): 1000, 2020, 3000

	BIAŁY (lakierowany) white (lacquered)	CZARNY (anodowany) black (anodized)	INOX (anodowany) inox (anodized)	SREBRNY (anodowany) silver (anodized)	SUROWY raw
Kolory profili Profile colors					
1,0 m	10-0041-10	10-0042-10	10-0043-10	10-0044-10	10-0040-10
2,02 m	10-0041-20	10-0042-20	10-0043-20	10-0044-20	10-0040-20
3,0 m	10-0041-30	10-0042-30	10-0043-30	10-0044-30	10-0040-30
Szerokość taśmy LED (mm) LED strip width (mm)	do 12 up to 12				

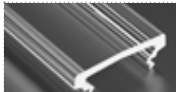
Klosze (PVC/PMMA/PC) / Covers





Wymiary [mm] / Dimensions (mm): 1000, 2020, 3000

TRANSPARENTNY transparent	MROŻONY frozen	MLECZNY milky	FROSTED MLECZNY milky frosted	CZARNY PMMA black PMMA	LENS 15 lens 15	LENS 30 lens 30
BASIC						
						
1 m/PMMA 11-2350-10 1 m/PC 11-3013-10	1 m/PMMA 11-2302-10 1 m/PC 11-3012-10	1 m/PMMA 11-2251-10 1 m/PC 11-3011-10	1 m/PMMA 11-2406-10	1 m/PMMA 11-2017-10	1 m/PMMA 11-2060-10	1 m/PMMA 11-2080-10
HIGH						
						
1 m/PMMA 11-2053-10	1 m/PMMA 11-2052-10	1 m/PMMA 11-2051-10	1 m/PMMA 11-2056-10	1 m/PMMA 11-2057-10		

Zasłepki (aluminium i tworzywo sztuczne) / End caps (aluminum and plastic)

Z OTWOREM with a hole				BEZ OTWORU without a hole			
BIAŁY white	CZARNY black	INOX inox	SREBRNY / SZARY silver / gray	BIAŁY white	CZARNY black	INOX inox	SREBRNY / SZARY silver / gray
BASIC							
							
ABS 12-0051-00	ABS 12-0052-00	ABS 12-0053-00	ABS 12-0054-00	ABS 12-0051-01	ABS 12-0052-01	ABS 12-0053-01	ABS 12-0054-01
	ALU 12-0052-10		ALU 12-0055-10 ALU lacq. 12-0000-41		ALU 12-0052-11		ALU 12-0055-11 ALU lacq. 12-0000-42
HIGH							
							
ABS 12-0061-00	ABS 12-0062-00	ABS 12-0063-00	ABS 12-0064-00	ABS 12-0061-01	ABS 12-0062-01	ABS 12-0063-01	ABS 12-0064-01
	ALU 12-0062-10		ALU 12-0065-10 ALU lacq. 12-0000-40		ALU 12-0062-11		ALU 12-0065-11 ALU lacq. 12-0000-39

Dodatki / Accessories

UCHWYT D MINI mounting clip D MINI	UCHWYT D HIGH mounting clip D HIGH	UCHWYT D METALOWY metal mounting clip D	ZAWIAS hinge
			
13-0053-00	13-0063-00	13-0140-02	14-6045-00

D
LUMINES[®]



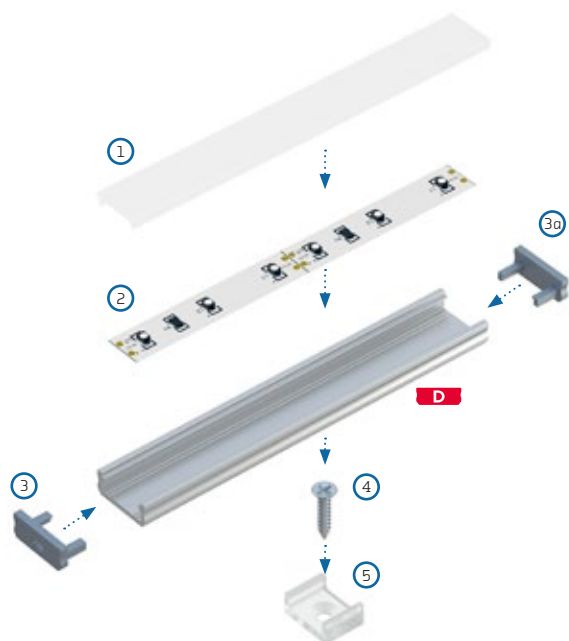

PL

Schemat złożenia elementów systemu oświetleniowego z wykorzystaniem profilu D oraz (1) klosza BASIC, (2) taśmy LED, (3) zaślepki z otworem, (3a) zaślepki bez otworu, (4) wkrętu montażowego, (5) uchwytem montażowego D MINI.

EN

Assembly scheme for elements of the lighting system using (1) a BASIC cover, (2) a LED strip, (3) an end cap with hole, (3a) an end cap without hole, (4) a mounting screw, (5) with a D MINI mounting clip.

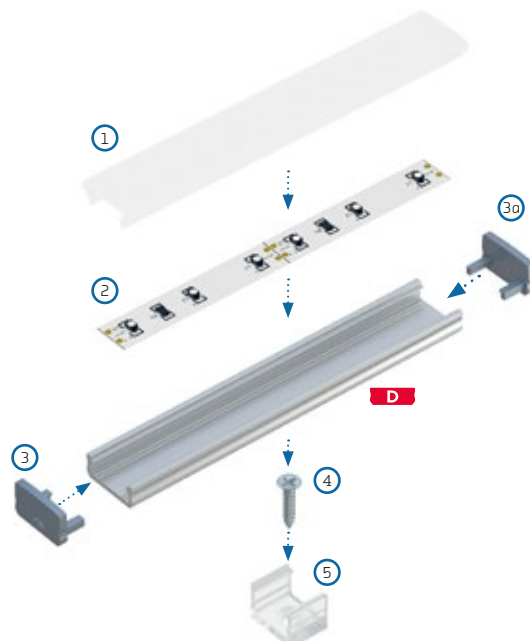

PL

Schemat złożenia elementów systemu oświetleniowego z wykorzystaniem profilu D oraz (1) klosza HIGH, (2) taśmy LED, (3) zaślepki z otworem, (3a) zaślepki bez otworu, (4) wkrętu montażowego, (5) uchwytem montażowego D HIGH.

EN

Assembly scheme for elements of the lighting system using (1) a HIGH cover, (2) a LED strip, (3) an end cap with hole, (3a) an end cap without hole, (4) a mounting screw, (5) with a D HIGH mounting clip.



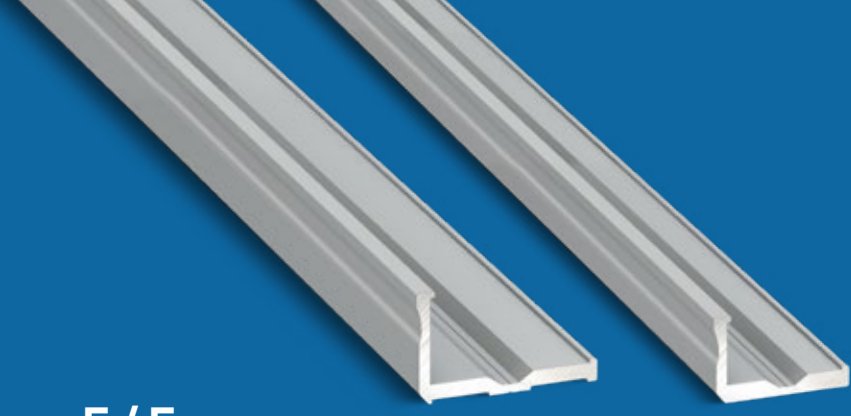

E / F

Profil LED / Profile LED

PL

Profil nawierzchniowy – do oświetlenia pomieszczeń gospodarczych, domowych – we wnękach, do półek meblowych.

EN

Surface-mounted profile – for lighting utility rooms, homes – in niches, shelves.

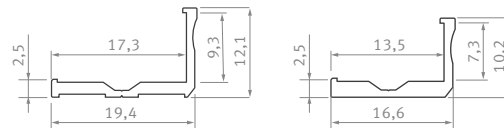

E / F



Sposoby montażu /
Assembly methods

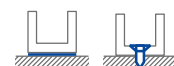



E



Profil LED / Profile LED

Wymiary [mm] / Dimensions [mm]: 1000, 2020, 3000

	BIAŁY (lakierowany) white (lacquered)	SREBRNY (anodowany) silver (anodized)	SUROWY raw
Kolory profili Profile colors			
1,0 m	10-0051-10	10-0054-10	10-0050-10
2,02 m	10-0051-20	10-0054-20	10-0050-20
3,0 m	10-0051-30	10-0054-30	10-0050-30
Szerokość taśmy LED [mm] LED strip width [mm]	do 16 up to 16		

F

Profil LED / Profile LED

Wymiary [mm] / Dimensions [mm]: 1000, 2020, 3000

	BIAŁY (lakierowany) white (lacquered)	SREBRNY (anodowany) silver (anodized)	SUROWY raw
Kolory profili Profile colors			
1,0 m	10-0061-10	10-0064-10	10-0060-10
2,02 m	10-0061-20	10-0064-20	10-0060-20
3,0 m	10-0061-30	10-0064-30	10-0060-30
Szerokość taśmy LED [mm] LED strip width [mm]	do 12 up to 12		



PL
Schemat montażu profilu E pod półkami.

EN
Installation scheme for profile E under shelves.

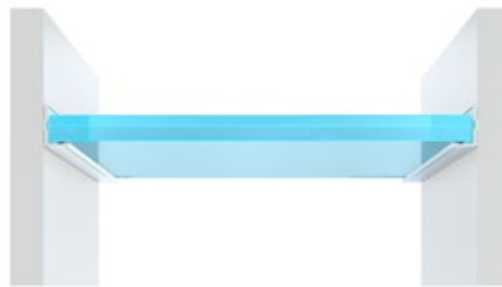

PL
Schemat montażu profilu F do półek szklanych.

EN
Installation scheme for profile F for glass shelves.







G

Profil LED / Profile LED

PL

Profil wpuszczany – do oświetlenia pomieszczeń kuchennych, sklepowych – oświetlenie szaf, blatów, schodów.

EN

Groove mounted profile – for lighting kitchens and stores – lighting for shelves, countertops, stairs.

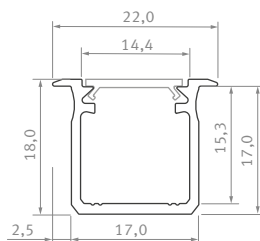

Sposoby montażu /
Assembly methods







G

G







Profil LED / Profile LED

Wymiary [mm] / Dimensions (mm): 1000, 2020, 3000

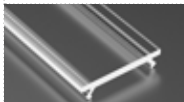
	BIAŁY (lakierowany) white (lacquered)	CZARNY (anodowany) black (anodized)	INOX (anodowany) inox (anodized)	SREBRNY (anodowany) silver (anodized)	SUROWY raw
Kolory profili Profile colors					
1,0 m	10-0071-10	10-0072-10	10-0073-10	10-0074-10	10-0070-10
2,02 m	10-0071-20	10-0072-20	10-0073-20	10-0074-20	10-0070-20
3,0 m	10-0071-30	10-0072-30	10-0073-30	10-0074-30	10-0070-30
Szerokość taśmy LED (mm) LED strip width (mm)	do 12 up to 12				

Klosze (PVC/PMMA/PC) / Covers

Wymiary [mm] / Dimensions (mm): 1000, 2020, 3000

TRANSPARENTNY transparent	MROŻONY frozen	MLECZNY milky	FROSTED MLECZNY milky frosted	CZARNY PMMA black PMMA	LENS 15 lens 15	LENS 30 lens 30
BASIC						
						
1 m/PMMA 11-2350-10 1 m/PC 11-3013-10	1 m/PMMA 11-2302-10 1 m/PC 11-3012-10	1 m/PMMA 11-2251-10 1 m/PC 11-3011-10	1 m/PMMA 11-2406-10	1 m/PMMA 11-2017-10	1 m/PMMA 11-2060-10	1 m/PMMA 11-2080-10

Zaślepki (aluminium i tworzywo sztuczne) / End caps (aluminum and plastic)

Z OTWOREM with a hole			
BIAŁY white	CZARNY black	INOX inox	SREBRNY / SZARY silver / gray
BASIC			
			
ABS 12-0071-00	ALU 12-0072-10 ABS 12-0072-00	ABS 12-0073-00	ALU 12-0075-10 ABS lacq. 12-0000-49 ABS 12-0074-00

Dodatki / Accessories

PROFIL MONTAŻOWY Y M1 assembly profile Y M1	WŁĄCZNIK BEZDOTYKOWY contactless switch
	
10-0654-10	14-7052-00



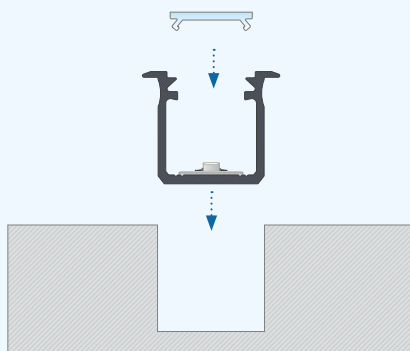

PL
Instrukcja montażu profilu G wpuszczanego z kloszem BASIC.

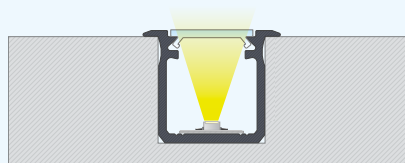

EN
Installation instruction for recessed profile G with a BASIC cover.

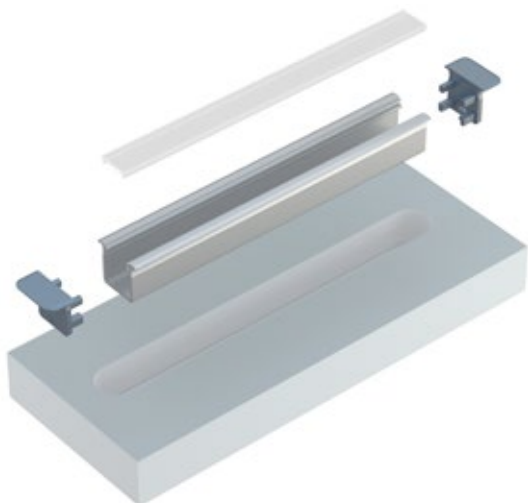

PL
Rzut aksonometryczny przed montażem profilu G wewnątrz wyfrezowanego otworu z kloszem BASIC oraz zaślepkami bocznymi.

EN
Isometric view before mounting profile G inside a milled groove with BASIC cover and end caps.



PL
Efekt końcowy montażu profilu G wpuszczanego z kloszem BASIC w płycie gipsowej.

EN
The end result of installation of recessed profile G with a BASIC cover in a plasterboard.

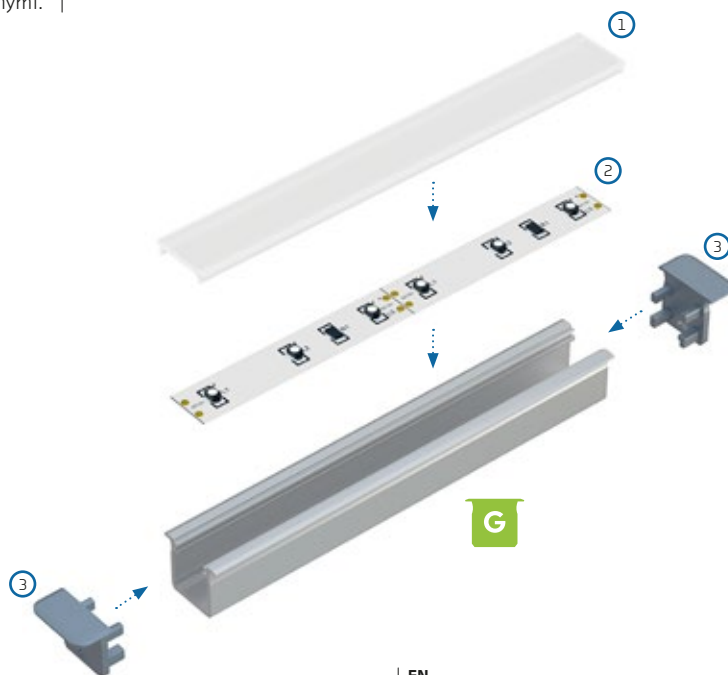

PL
Schemat złożenia elementów systemu oświetleniowego z wykorzystaniem profilu G oraz (1) klosza BASIC, (2) taśmy LED, (3) zaślepek z otworami.

EN
Assembly schematic for the elements of the lighting system using recessed profile G and (1) a BASIC cover, (2) a LED strip, (3) end caps with hole.

J

Profil LED / Profile LED

PL
Profil wpuszczany – do umieszczenia w wyfrezowanym otworze. Profil jest wykończony jednostronnie, dzięki czemu pozwala na spasowanie z prostopadłą powierzchnią.

EN
Recessed profile – to be installed in a milled groove. The profile is finished on one side, which allows it to fit with a perpendicular surface.

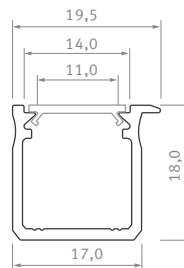

Sposoby montażu /
Assembly methods







J

J



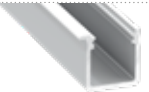



Profil LED / Profile LED

Wymiary [mm] / Dimensions (mm): 1000, 2020, 3000

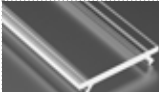
	BIAŁY (lakierowany) white (lacquered)	CZARNY (anodowany) black (anodized)	INOX (anodowany) inox (anodized)	SREBRNY (anodowany) silver (anodized)	SUROWY raw
Kolory profili Profile colors					
1,0 m	10-0000-88	10-0000-93	10-0000-98	10-0001-03	10-0001-08
2,02 m	10-0000-89	10-0000-94	10-0000-99	10-0001-04	10-0001-09
3,0 m	10-0000-90	10-0000-95	10-0000-01	10-0001-05	10-0001-10
Szerokość taśmy LED (mm) LED strip width (mm)	do 12 up to 12				

Klosze (PVC/PMMA/PC) / Covers

Wymiary [mm] / Dimensions (mm): 1000, 2020, 3000

TRANSPARENTNY transparent	MROŻONY frozen	MLECZNY milky	FROSTED MLECZNY milky frosted	CZARNY PMMA black PMMA	LENS 15 lens 15	LENS 30 lens 30
BASIC						
						
1 m/PMMA 11-2350-10 1 m/PC 11-3013-10	1 m/PMMA 11-2302-10 1 m/PC 11-3012-10	1 m/PMMA 11-2251-10 1 m/PC 11-3011-10	1 m/PMMA 11-2406-10	1 m/PMMA 11-2017-10	1 m/PMMA 11-2060-10	1 m/PMMA 11-2080-10

Zaślepki (tworzywo sztuczne) / End caps (plastic)

Z OTWOREM with a hole							
BIAŁY white	CZARNY black	INOX inox	SREBRNY / SZARY silver / gray				
BASIC							
PRAWA right	LEWA left	PRAWA right	LEWA left	PRAWA right	LEWA left	PRAWA right	LEWA left
							
ABS 12-0000-63	ABS 12-0000-64	ABS 12-0000-65	ABS 12-0000-66	ABS 12-0000-67	ABS 12-0000-68	ABS locq.12-1185-00 ABS 12-0000-69	ABS locq.12-1085-00 ABS 12-0000-70

Dodatki / Accessories

PROFIL MONTAŻOWY Y M1 assembly profile Y M1	WŁĄCZNIK BEZDOTYKOWY contactless switch
	
10-0654-10	14-7052-00

LUMINES[®]
LIGHTING

J
LUMINES



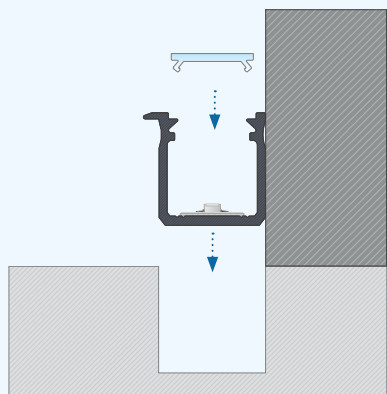

PL
Instrukcja montażu profilu J
wpuszczanego z kloszem BASIC.

EN
Installation instruction for re-
cessed profile J with a BASIC
cover.

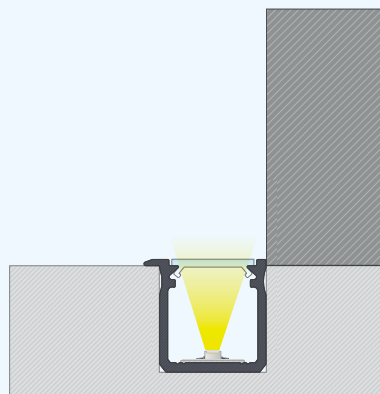

PL
Efekt końcowy montażu profilu J
wpuszczanego z kloszem BASIC.

EN
The end result of installation of
recessed profile J with a BASIC
cover.



H

Profil LED / Profile LED

PL
Profil kątowy 30°/60° – do oświetlenia pomieszczeń kuchennych, wnęk szaf, schodów. Zbudowany niesymetrycznie, do stosowania różnych kątów świecenia.

EN
Corner profile 30°/60° – for lighting kitchens, closets and stairs. Built as asymmetrical, to be used for various lighting angle.

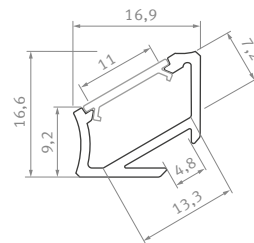

Sposoby montażu /
Assembly methods

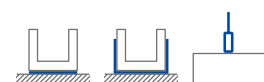

H



Profil LED / Profile LED

Wymiary [mm] / Dimensions (mm): 1000, 2020, 3000

	BIAŁY (lakierowany) white (lacquered)	CZARNY (anodowany) black (anodized)	INOX (anodowany) inox (anodized)	SREBRNY (anodowany) silver (anodized)	SUROWY raw
Kolory profili Profile colors					
1,0 m	10-0451-10	10-0452-10	10-0453-10	10-0454-10	10-0450-10
2,02 m	10-0451-20	10-0452-20	10-0453-20	10-0454-20	10-0450-20
3,0 m	10-0451-30	10-0452-30	10-0453-30	10-0454-30	10-0450-30
Szerokość taśmy LED (mm) LED strip width (mm)	do 12 up to 12				

Klosze (PVC/PMMA/PC) / Covers

Wymiary [mm] / Dimensions (mm): 1000, 2020, 3000

TRANSPARENTNY transparent	MROŻONY frozen	MLECZNY milky	FROSTED MLECZNY milky frosted	CZARNY PMMA black PMMA	LENS 15 lens 15	LENS 30 lens 30
BASIC						
1 m/PMMA 11-2350-10	1 m/PMMA 11-2302-10	1 m/PMMA 11-2251-10	1 m/PMMA 11-2406-10	1 m/PMMA 11-2017-10	1 m/PMMA 11-2060-10	1 m/PMMA 11-2080-10
1 m/PC 11-3013-10	1 m/PC 11-3012-10	1 m/PC 11-3011-10				

Zaślepki (aluminium i tworzywo sztuczne) / End caps (aluminum and plastic)

BASIC							
Z OTWOREM with a hole				BEZ OTWORU without a hole			
CZARNY black		SREBRNY silver		CZARNY black		SREBRNY silver	
LEWA left	PRAWA right	LEWA left	PRAWA right	LEWA left	PRAWA right	LEWA left	PRAWA right
ALU 12-0262-10	ALU 12-1012-10	ALU 12-0265-10	ALU 12-1015-10	ALU 12-0262-11	ALU 12-1012-11	ALU 12-0265-11	ALU 12-1015-11
BASIC							
Z OTWOREM TRASOWANYM with push-hole							
BIAŁY white		CZARNY black		INOX inox		SZARY / SREBRNY gray / silver	
LEWA left	PRAWA right	LEWA left	PRAWA right	LEWA left	PRAWA right	LEWA left	PRAWA right
ABS 12-0941-01	ABS 12-0951-01	ABS 12-0942-01	ABS 12-0952-01	ABS 12-0943-01	ABS 12-0953-01	ABS lacq. 12-0000-43	ABS lacq. 12-0000-44
						ABS 12-0944-01	ABS 12-0954-01

Dodatki / Accessories

TRANSPARENTNY, BIAŁY, CZARNY transparent, white, black						
UCHWYT CH mounting clip CH	UCHWYT CH METALOWY metal mounting clip CH	UCHWYT CH KĄTOWY angled mounting clip CH	ZAWIAS hinge	WŁĄCZNIK BEZDOTYKOWY contactless switch	UCHWYT NA PRZEWÓD Ø 5 mm cable fi 5 mm holder	ZAWIESIA pendants
13-0043-00	13-0120-02	13-0103-00	14-6045-00	14-7052-00	*T 14-7067-00 *B 14-7067-02	*S 14-2011-02 *B 14-2076-00 *W 14-2075-00

* S SREBRNY silver; * B CZARNY black; * T TRANSPARENTNY transparent; * W BIAŁY white



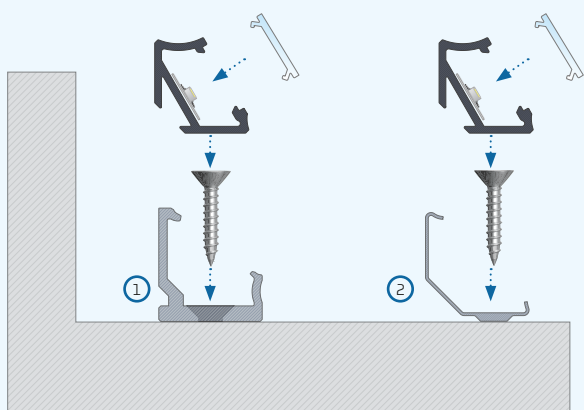

PL
Instrukcja montażu profilu H pod kątem 60° z kloszem BASIC za pomocą (1) uchwyty montażowe-go CH z tworzywa, (2) metalowego uchwyty montażowego CH.

EN
Installation instructions for profile H at 60 degrees with BASIC cover using (1) a plastic mounting clip CH, (2) a metal mounting clip CH.

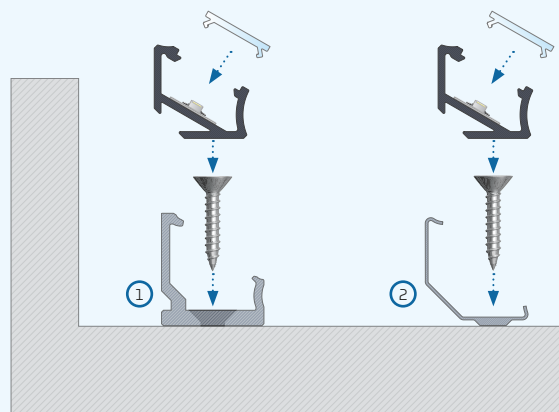

PL
Instrukcja montażu profilu CH pod kątem 30° z kloszem BASIC za pomocą (1) uchwyty montażowe-go CH z tworzywa, (2) metalowego uchwyty montażowego CH.

EN
Installation instructions for profile H at 30 degrees with BASIC cover using (1) a plastic mounting clip CH, (2) a metal mounting clip CH.



I6 / I10

Profil LED / Profile LED

PL
Profil szlutowy/plexi – do mocowania i oświetlenia półek sklepowych, tabliczek informacyjnych i ozdobnych.

EN
Glass / plexi profile – for mounting and lighting store shelves, informative and decorative plates.

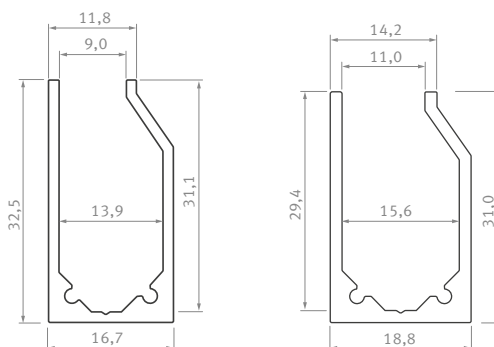

I6 / I10



Sposoby montażu /
Assembly methods



I6

I6 I10

Profil LED / Profile LED

Wymiary [mm] / Dimensions (mm): 1000, 2020, 3000

















Kolory profili Profile colors	SREBRNY (anodowany) silver (anodized)	
		
	1,0 m	10-0474-10
	2,02 m	10-0474-20
	3,0 m	10-0474-30
Szerokość taśmy LED [mm] LED strip width [mm]		do 10 up to 10

Dotatki / Accessories

	PROFIL FARI Profile FARI	ZAWIESIA pendants	UCHWYT NA PRZEWÓD \varnothing 5 mm cable \varnothing 5 mm holder
			
1,0 m	10-0434-10	*S 14-2011-02	*T 14-7067-00
2,02 m	10-0434-20	*B 14-2076-00	*B 14-7067-02
3,0 m	10-0434-30	*W 14-2075-00	

* S SREBRNY silver; * B CZARNY black; * T TRANSPARENTNY transparent; * W BIAŁY white

Zasłepki (aluminium) / End caps (aluminum)

	Z OTWOREM with a hole		BEZ OTWORU without a hole		Z OTWOREM with a hole		BEZ OTWORU without a hole	
	SREBRNY silver		SREBRNY silver		SREBRNY silver		SREBRNY silver	
	Z PODPORĄ with support		Z PODPORĄ with support		BEZ PODPORY without support		BEZ PODPORY without support	
	PRAWA right	LEWA left	PRAWA right	LEWA left	PRAWA right	LEWA left	PRAWA right	LEWA left
6 mm								
	ABS 12-0325-10; ABS 12-0345-10		ABS 12-0325-11; ABS 12-0345-11		ABS 12-0315-10; ABS 12-0335-10		ABS 12-0315-11; ABS 12-0335-11	
8 mm								
	ABS 12-0365-10; ABS 12-0385-10		ABS 12-0365-11; ABS 12-0385-11		ABS 12-0355-10; ABS 12-0375-10		ABS 12-0355-11; ABS 12-0375-11	

I10

Profil LED / Profile LED

Wymiary [mm] / Dimensions (mm): 1000, 2020, 3000









Kolory profili Profile colors	SREBRNY (anodowany) silver (anodized)	
		
	1,0 m	10-0464-10
	2,02 m	10-0464-20
	3,0 m	10-0464-30
Szerokość taśmy LED [mm] LED strip width [mm]		do 10 up to 10

Dotatki / Accessories

	GUMA DO PROFILI I6 / I10 (CZARNA) Rubber tape for profiles I6 / I10 (black)	ZAWIESIA pendants	UCHWYT NA PRZEWÓD \varnothing 5 mm cable \varnothing 5 mm holder
			
	1 m / 14-5057-01	*S 14-2011-02 *B 14-2076-00 *W 14-2075-00	*T 14-7067-00 *B 14-7067-02

* S SREBRNY silver; * B CZARNY black; * T TRANSPARENTNY transparent; * W BIAŁY white

Zasłepki (aluminium) / End caps (aluminum)

	Z OTWOREM with a hole		BEZ OTWORU without a hole		Z OTWOREM with a hole		BEZ OTWORU without a hole	
	SREBRNY silver		SREBRNY silver		SREBRNY silver		SREBRNY silver	
	Z PODPORĄ with support		Z PODPORĄ with support		BEZ PODPORY without support		BEZ PODPORY without support	
	LEWA left	PRAWA right	LEWA left	PRAWA right	LEWA left	PRAWA right	LEWA left	PRAWA right
10 mm								
	12-0285-10	12-0305-10	12-0285-11	12-0305-11	12-0275-10	12-0295-10	12-0275-11	12-0295-11



110
LUMINES

GATE
PRZEJŚCIE



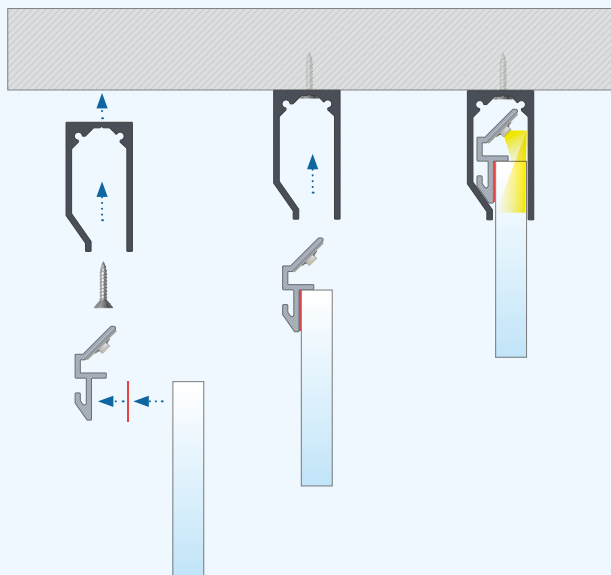

PL
Schemat kolejności montażu profili szklowych I6/I10 za pomocą taśmy dwustronnej, profilu pomocniczego FARI i wkrętu montażowego.

EN
Installation sequence diagram for glass I6/I10 profiles using a double-sided tape, assembly profile FARI and mounting screw.



PL
Efekt końcowy montażu profilu I10 z szybą jako element stały przytwierdzony do powierzchni pionowej za pomocą dedykowanych zaślepek z podporami.

EN
End result of the installation of I10 glass profile as the fixed element, mounted to the vertical surface using dedicated end caps with support.

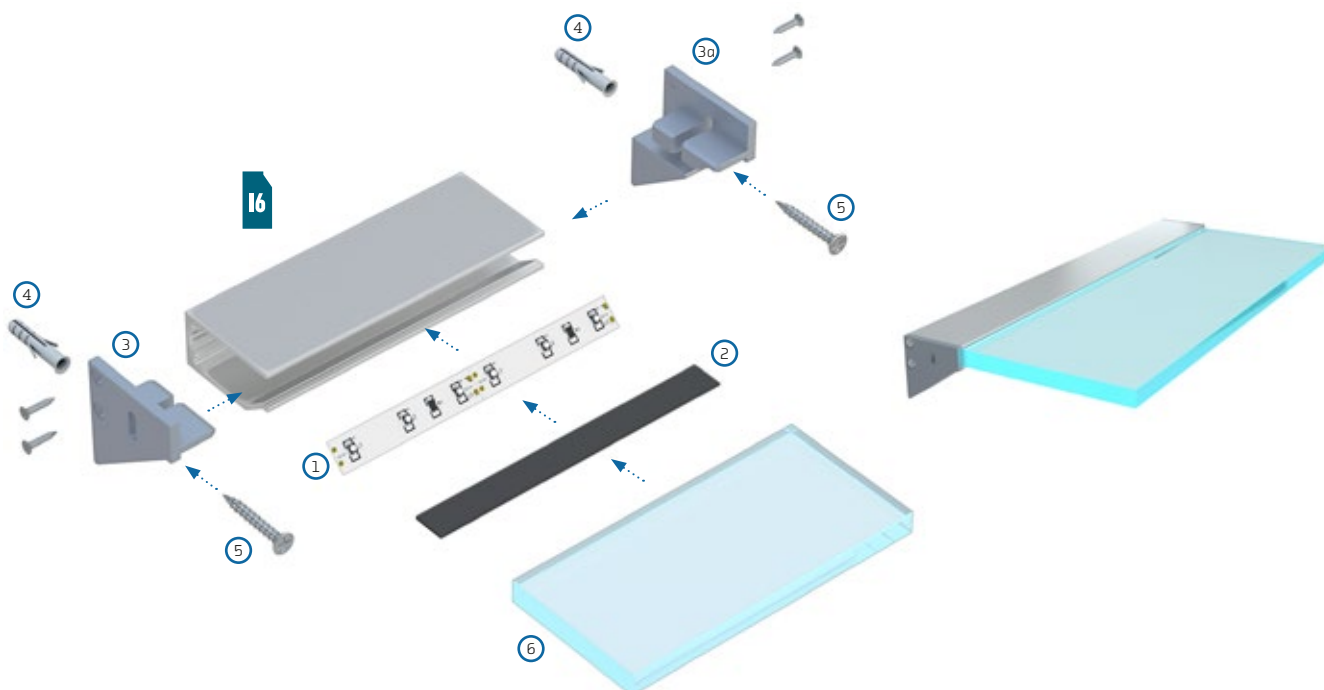

PL
Schemat złożenia elementów systemu oświetleniowego z wykorzystaniem profilu I6 oraz [1] taśmy LED, [2] gumy do profili, [3] zaślepek montażowej z podporą z otworem, [3a] zaślepek montażowej z podporą bez otworu, [4] kołków montażowych, [5] wkrętów montażowych, [6] plexi/szyby.

EN
Assembly scheme for elements of the lighting system using profile I6 and [1] a LED strip, [2] a rubber tape for profiles, [3] a mounting cap with support with hole, [3a] a mounting cap with support without hole, [4] mounting pins, [5] mounting screws, [6] glass or plexiglass.

Q18 / Q20

Profil LED / Profile LED

PL
Profil kątowy 45° – oświetlenie szaf, blatów.

EN
Angle profile 45 degrees – lighting for shelves, countertops.

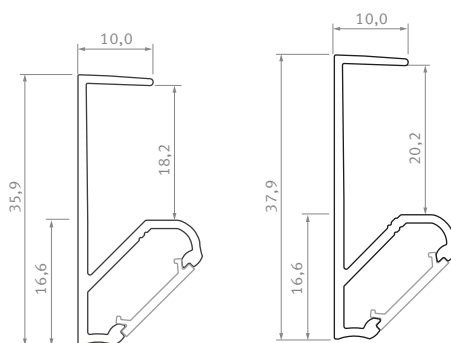

Q18 / Q20



Sposoby montażu /
Assembly methods







Q18









Profil LED / Profile LED

Wymiary [mm] / Dimensions (mm): 1000, 2020, 3000

	BIAŁY (lakierowany) white (lacquered)	CZARNY (anodowany) black (anodized)	INOX (anodowany) inox (anodized)	SREBRNY (anodowany) silver (anodized)	SUROWY raw
Kolory profili Profile colors					
1,0 m	10-0691-10	10-0692-10	10-0693-10	10-0694-10	10-0690-10
2,02 m	10-0691-20	10-0692-20	10-0693-20	10-0694-20	10-0690-20
3,0 m	10-0691-30	10-0692-30	10-0693-30	10-0694-30	10-0690-30
Szerokość taśmy LED (mm) LED strip width (mm)	do 12 up to 12				

Klosze (PVC/PMMA/PC) / Covers





Wymiary [mm] / Dimensions (mm): 1000, 2020, 3000

TRANSPARENTNY transparent	MROŻONY frozen	MLECZNY milky	FROSTED MLECZNY milky frosted	CZARNY PMMA black PMMA	LENS 15 lens 15	LENS 30 lens 30
BASIC						
						
1 m/PMMA 11-2350-10 1 m/PC 11-3013-10	1 m/PMMA 11-2302-10 1 m/PC 11-3012-10	1 m/PMMA 11-2251-10 1 m/PC 11-3011-10	1 m/PMMA 11-2406-10	1 m/PMMA 11-2017-10	1 m/PMMA 11-2060-10	1 m/PMMA 11-2080-10

Q20







Profil LED / Profile LED

Wymiary [mm] / Dimensions (mm): 1000, 2020, 3000

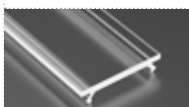
	BIAŁY (lakierowany) white (lacquered)	CZARNY (anodowany) black (anodized)	INOX (anodowany) inox (anodized)	SREBRNY (anodowany) silver (anodized)	SUROWY raw
Kolory profili Profile colors					
1,0 m	10-0001-13	10-0001-18	10-0001-23	10-0001-27	10-0001-32
2,02 m	10-0001-14	10-0001-19	10-0001-24	10-0001-28	10-0001-33
3,0 m	10-0001-15	10-0001-20	10-0001-25	10-0001-29	10-0001-34
Szerokość taśmy LED (mm) LED strip width (mm)	do 12 up to 12				

Klosze (PVC/PMMA/PC) / Covers

Wymiary [mm] / Dimensions (mm): 1000, 2020, 3000

TRANSPARENTNY transparent	MROŻONY frozen	MLECZNY milky	FROSTED MLECZNY milky frosted	CZARNY PMMA black PMMA	LENS 15 lens 15	LENS 30 lens 30
BASIC						
						
1 m/PMMA 11-2350-10 1 m/PC 11-3013-10	1 m/PMMA 11-2302-10 1 m/PC 11-3012-10	1 m/PMMA 11-2251-10 1 m/PC 11-3011-10	1 m/PMMA 11-2406-10	1 m/PMMA 11-2017-10	1 m/PMMA 11-2060-10	1 m/PMMA 11-2080-10



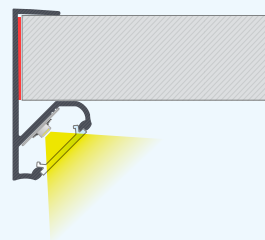
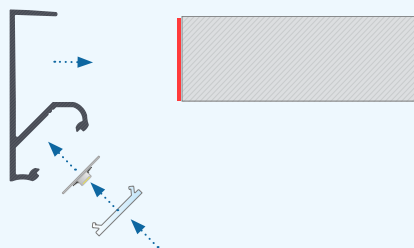

PL
Instrukcja montażu profilu Q18 z kloszem BASIC za pomocą taśmy dwustronnej.

EN
Installation instruction for corner profile Q18 with a BASIC cover using a double-sided tape.



PL
Sposób łączenia profili Q18 z kloszem BASIC z półką.

EN
The method of connecting Q18 profiles with a BASIC cover with a shelf.

PL
Schemat przeprowadzenia przewodu zasilającego wraz ze złożeniem systemu oświetleniowego z wykorzystaniem profilu Q18, taśmy LED i klosza Basic.

EN
Diagram of the power cord routing with the assembly of the lighting system with the use of the Q18 profile, LED strip and Basic cover.

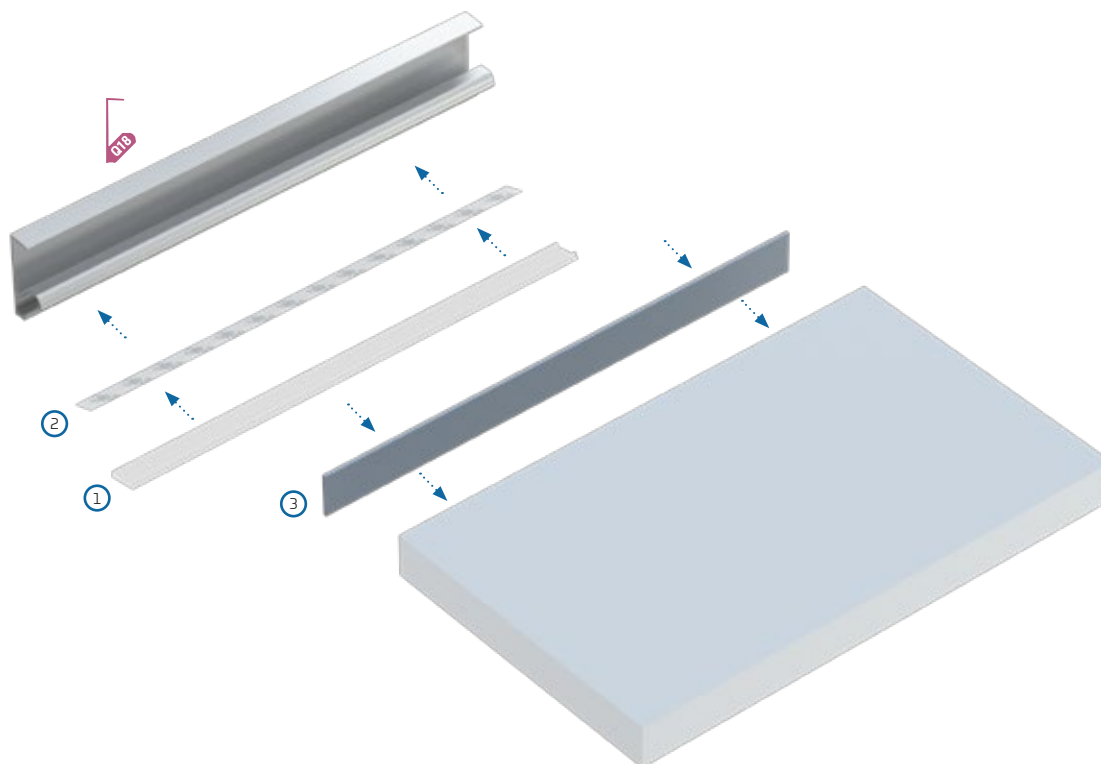

PL
Schemat złożeniem systemu oświetleniowego z wykorzystaniem profilu Q18, (2) taśmy LED, (1) klosza Basic i (3) dwustronnej taśmy montażowej.

EN
Assembly diagram of the lighting system using the Q18 profile, (2) LED strip, (1) Basic cover and (3) double-sided mounting tape.

NEW
2023

U

Profil LED / Profile LED

PL
Profil LED wpuszczany o wysokości dostosowanej do standardowej płyty GK lub płyty meblowej 12mm. Pozwala na szybki montaż wpuszczany bez koniecznego wykończenia gładzi szpachlową.

EN
LED recessed profile with a height adjusted to a standard 12mm plasterboard or furniture board. Allows for quick recessed installation without the need for finishing with finishing coat.

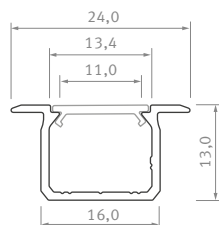

Sposoby montażu /
Assembly methods







U

U







Profil LED / Profile LED

Wymiary [mm] / Dimensions [mm]: **1000, 2020, 3000**

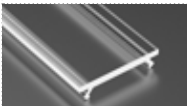
	BIAŁY (lakierowany) white (lacquered)	CZARNY (anodowany) black (anodized)	SREBRNY (anodowany) silver (anodized)	SUROWY raw
Kolory profili Profile colors				
1,0 m	10-1031-10	10-1042-10	10-1054-10	10-1060-10
2,02 m	10-1031-20	10-1042-20	10-1054-20	10-1060-20
3,0 m	10-1031-30	10-1042-30	10-1054-30	10-1060-30
Szerokość taśmy LED [mm] LED strip width [mm]	do 12 up to 12			

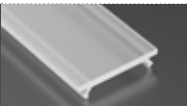
Klosze (PVC/PMMA/PC) / Covers

Wymiary [mm] / Dimensions [mm]: **1000, 2020, 3000**

TRANSPARENTNY transparent	MROŻONY frozen	MLECZNY milky	FROSTED MLECZNY milky frosted	CZARNY PMMA black PMMA	LENS 15 lens 15	LENS 30 lens 30
BASIC						
						
1 m/PMMA 11-2350-10	1 m/PMMA 11-2302-10	1 m/PMMA 11-2251-10	1 m/PMMA 11-2406-10	1 m/PMMA 11-2017-10	1 m/PMMA 11-2060-10	1 m/PMMA 11-2080-10
1 m/PC 11-3013-10	1 m/PC 11-3012-10	1 m/PC 11-3011-10				

Zaślepki (tworzywo sztuczne) / End caps (plastic)

Z OTWOREM with a hole			
BIAŁY white	CZARNY black	SREBRNY silver	SZARY gray
BASIC			
			
ABS 12-1061-00	ABS 12-1062-00	ABS lacq. 12-1065-01	ABS 12-1064-00

Dodatki / Accessories

WŁĄCZNIK BEZDOTYKOWY contactless switch

14-7052-00



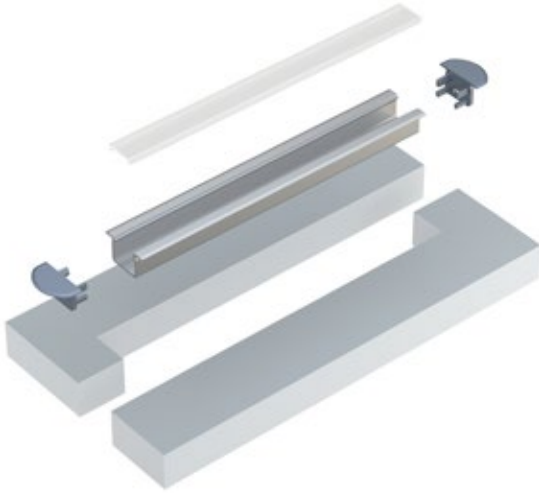

PL
Rzut aksonometryczny przed montażem profilu U wewnątrz wyfrezowanego otworu z kloszem BASIC oraz zaślepkami bocznymi.

EN
Isometric view before mounting profile U inside a milled groove with BASIC cover and end caps.

PL
Efekt końcowy montażu profilu U wpuszczanego z kloszem BASIC w płycie gipsowej.

EN
The end result of installation of recessed profile U with a BASIC cover in a plasterboard.



PL
Łączenie profili U z kloszem BASIC pod kątem 90° w płycie gipsowej.

EN
Connecting profiles U with a BASIC cover at 90 degrees in plasterboard.





W

Profil LED / Profile LED

PL
Profil wpuszczany – do montażu w lekkich konstrukcjach z zastosowaniem sprężyn montażowych.

EN
Recessed profile – for installation in lightweight structures with the use of mounting springs.

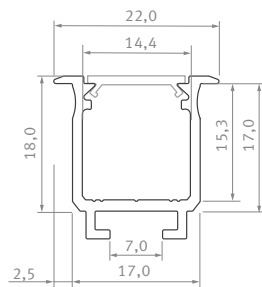

Sposoby montażu /
Assembly methods

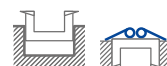

W



Profil LED / Profile LED

Wymiary [mm] / Dimensions (mm): 1000, 2020, 3000

	BIAŁY (lakierowany) white (lacquered)	CZARNY (anodowany) black (anodized)	INOX (anodowany) inox (anodized)	SREBRNY (anodowany) silver (anodized)	SUROWY raw
Kolory profili Profile colors					
1,0 m	10-0701-10	10-0702-10	10-0703-10	10-0704-10	10-0700-10
2,02 m	10-0701-20	10-0702-20	10-0703-20	10-0704-20	10-0700-20
3,0 m	10-0701-30	10-0702-30	10-0703-30	10-0704-30	10-0700-30
Szerokość taśmy LED (mm) LED strip width (mm)	do 12 up to 12				

Klosze (PVC/PMMA/PC) / Covers

Wymiary [mm] / Dimensions (mm): 1000, 2020, 3000

TRANSPARENTNY transparent	MROŻONY frozen	MLECZNY milky	FROSTED MLECZNY milky frosted	CZARNY PMMA black PMMA	LENS 15 lens 15	LENS 30 lens 30
BASIC						
1 m/PMMA 11-2350-10 1 m/PC 11-3013-10	1 m/PMMA 11-2302-10 1 m/PC 11-3012-10	1 m/PMMA 11-2251-10 1 m/PC 11-3011-10	1 m/PMMA 11-2406-10	1 m/PMMA 11-2017-10	1 m/PMMA 11-2060-10	1 m/PMMA 11-2080-10

Zaślepki (aluminium i tworzywo sztuczne) / End caps (aluminum and plastic)

Z OTWOREM with a hole			
BIAŁY white	CZARNY black	INOX inox	SREBRNY / SZARY silver / gray
BASIC			
ABS 12-0071-00	ALU 12-0072-10 ABS 12-0072-00	ABS 12-0073-00	ALU 12-0075-10 ABS lacq. 12-0000-49 ABS 12-0074-00

Dodatki / Accessories

SPRĘŻYNY MONTAŻOWE mounting springs	ŁĄCZNIK PROSTY straight connector	ŁĄCZNIK KĄTOWY 90° angular connector 90°	ŁĄCZNIK POPRZECZNY KĄTOWY angular transverse connector	ŁĄCZNIK KĄTOWY 120° angular connector 120°	PROFIL MONTAŻOWY Y M1 assembly profile Y M1	WŁĄCZNIK BEZDOTYKOWY contactless switch
14-5001-00	14-3032-02	14-3030-01	14-3038-01	14-3036-01	10-0654-10	14-7052-00



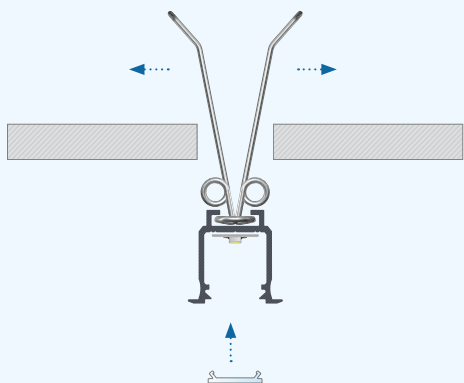

PL
Instrukcja montażu profilu W wpuszczanego z kloszem BASIC w suficie za pomocą sprężyn montażowych.

EN
Instruction of the assembly of profile W with BASIC cover in the ceiling using mounting springs.



PL
Łączenie profili W za pomocą łącznika prostego w wyfrezowanym otworze i montaż profili W z wykorzystaniem sprężyn montażowych.

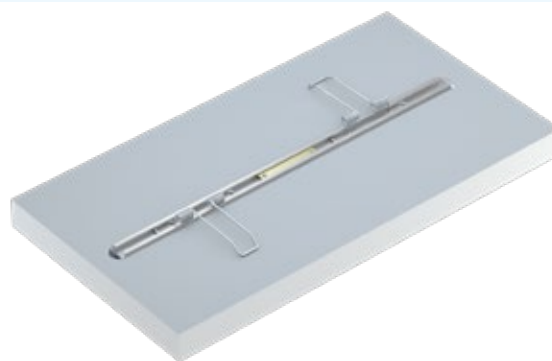

EN
Connecting W profiles using straight connector in a milled groove and assembly of W profiles with the use of assembly springs.

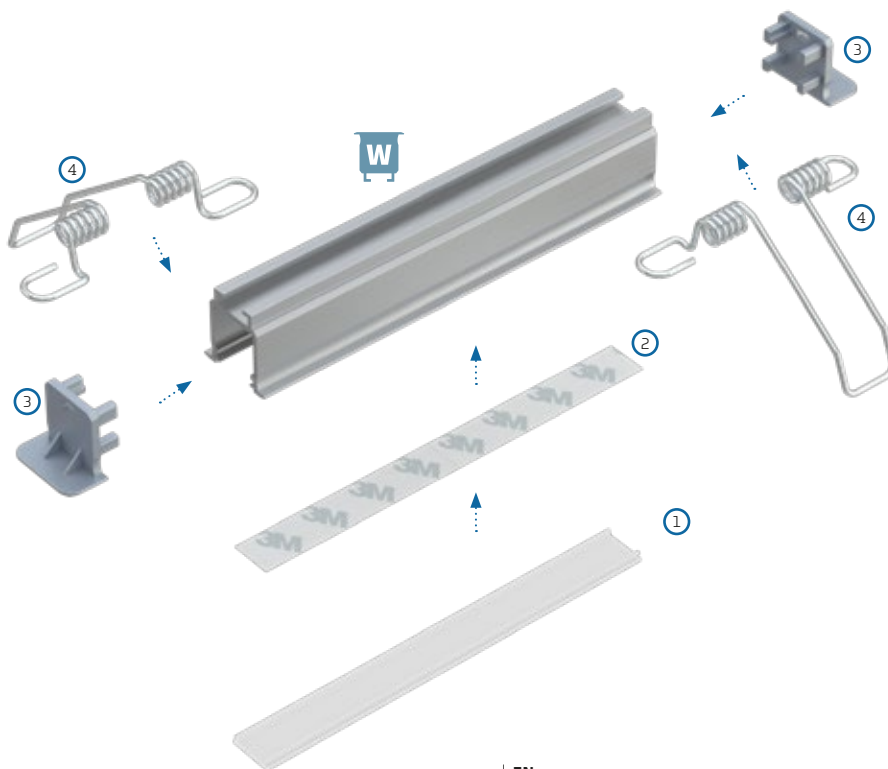

PL
Schemat złożenia elementów systemu oświetleniowego z wykorzystaniem profilu W oraz (1) klosza BASIC, (2) taśm LED, (3) zaślepek z otworem, oraz (4) sprężyn montażowych.

EN
Assembly scheme for elements of the lighting system using profile W and (1) BASIC cover (2), LED strips, (3) end caps with hole and (4) mounting springs.



X

Profil LED / Profile LED

PL
Profil nawierzchniowy – do dyskretnego oświetlenia pomieszczeń kuchennych, sklepowych – oświetlenie blatów, poręczy.

EN
Surface-mounted profile – for discrete lighting in kitchens, stores – lighting countertops, handrails.

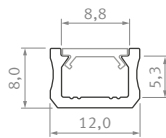

Sposoby montażu /
Assembly methods

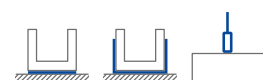



Profil LED / Profile LED

Wymiary [mm] / Dimensions (mm): 1000, 2020, 3000

	BIAŁY (lakierowany) white (lacquered)	CZARNY (anodowany) black (anodized)	INOX (anodowany) inox (anodized)	SREBRNY (anodowany) silver (anodized)	SUROWY raw
Kolory profili Profile colors					
1,0 m	10-0081-10	10-0082-10	10-0083-10	10-0084-10	10-0080-10
2,02 m	10-0081-20	10-0082-20	10-0083-20	10-0084-20	10-0080-20
3,0 m	10-0081-30	10-0082-30	10-0083-30	10-0084-30	10-0080-30
Szerokość taśmy LED (mm) LED strip width (mm)	do 8 up to 8				

Klosze (PVC/PMMA/PC) / Covers

Wymiary [mm] / Dimensions (mm): 1000, 2020, 3000

TRANSPARENTNY transparent	MROŻONY frozen	MLECZNY milky	FROSTED MLECZNY milky frosted	CZARNY PMMA black PMMA	SLIM LENS 15 slim lens 15
SLIM					
1 m/PMMA 11-2023-10	1 m/PMMA 11-2022-10	1 m/PMMA 11-2021-10	1 m/PMMA 11-2026-10	1 m/PMMA 11-2027-10	1 m/PMMA 11-2060-10

Zaślepki (aluminium i tworzywo sztuczne) / End caps (aluminum and plastic)

Z OTWOREM with a hole				BEZ OTWORU without a hole			
BIAŁY white	CZARNY black	INOX inox	SREBRNY / SZARY silver / gray	BIAŁY white	CZARNY black	INOX inox	SREBRNY / SZARY silver / gray
SLIM							
ABS 12-0081-00	ABS 12-0082-00	ABS 12-0083-00	ABS 12-0084-00	ABS 12-0081-01	ABS 12-0082-01	ABS 12-0083-01	ABS 12-0084-01
	ALU 12-0082-10		ALU 12-0085-10		ALU 12-0082-11		ALU 12-0085-11
			ABS lacq. 12-0000-46				ABS lacq. 12-0000-45

Dodatki / Accessories

TRANSPARENTNY, BIAŁY, CZARNY transparent, white, black		
UCHWYT X MINI mounting clip X MINI	UCHWYT X METALOWY metal mounting clip X	ZAWIAS hinge
13-0073-00	13-0160-02	14-6045-00

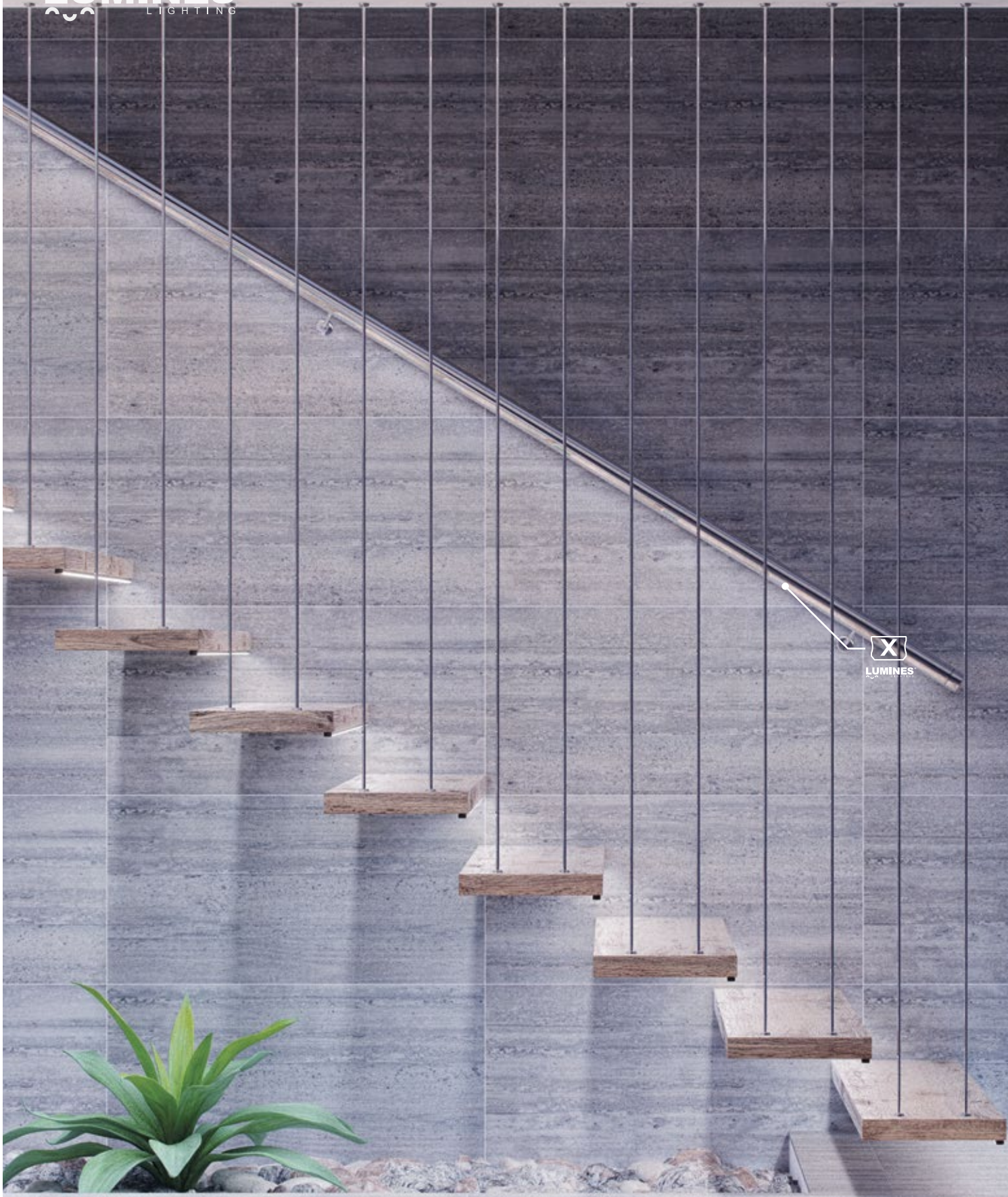

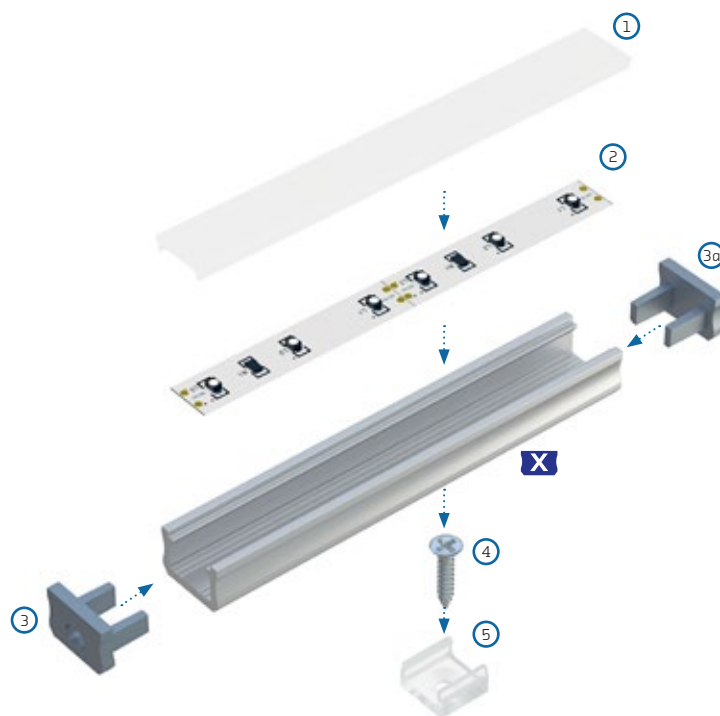

PL

Schemat złożenia elementów systemu oświetleniowego z wykorzystaniem profilu X oraz (1) klosza SLIM, (2) taśmy LED, (3) zaślepki z otworem, (3a) zaślepki bez otworu, (4) wkrętu montażowego, (5) uchwyty montażowego X.

EN

Assembly scheme for elements of the lighting system using profile X and (1) a SLIM cover, (2) a LED strip, (3) an end cap with hole, (3a) an end cap without hole, (4) a mounting screw, (5) a mounting clip X.

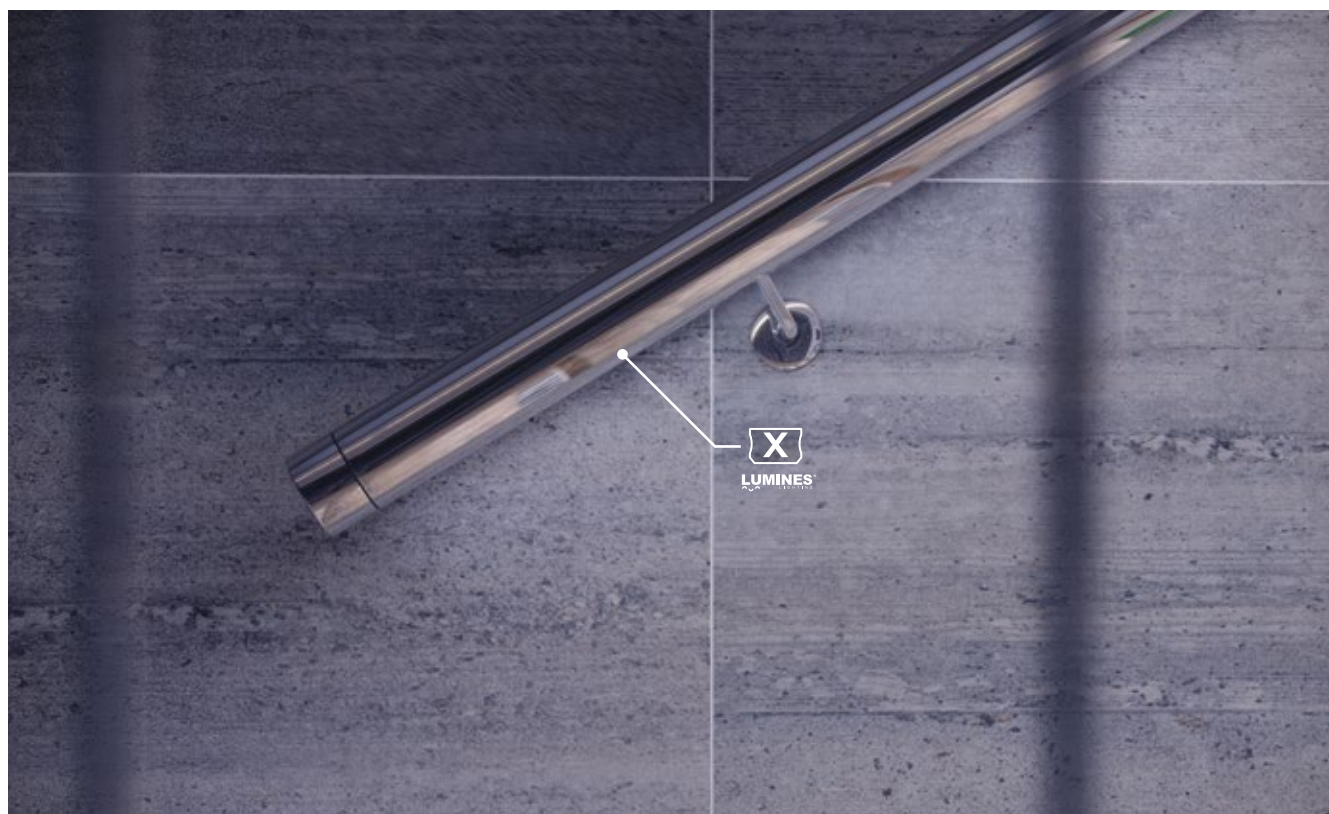

Y

Profil LED / Profile LED

PL

Profil nawierzchniowy – do oświetlenia pomieszczeń domowych, biurowych – oświetlenie kolumn, blatów.

EN

Surface-mounted profile – for household and office room illumination – lighting of columns, countertops.

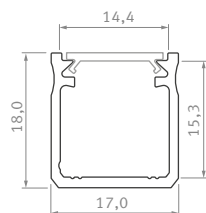

Sposoby montażu /
Assembly methods

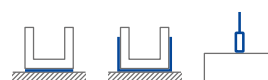



Profil LED / Profile LED

Wymiary [mm] / Dimensions [mm]: 1000, 2020, 3000

	BIAŁY (lakierowany) white (lacquered)	CZARNY (anodowany) black (anodized)	INOX (anodowany) inox (anodized)	SREBRNY (anodowany) silver (anodized)	SUROWY raw
Kolory profili Profile colors					
1,0 m	10-0091-10	10-0092-10	10-0093-10	10-0094-10	10-0090-10
2,02 m	10-0091-20	10-0092-20	10-0093-20	10-0094-20	10-0090-20
3,0 m	10-0091-30	10-0092-30	10-0093-30	10-0094-30	10-0090-30
Szerokość taśmy LED (mm) LED strip width (mm)	do 12 up to 12				

Klosze (PVC/PMMA/PC) / Covers

Wymiary [mm] / Dimensions [mm]: 1000, 2020, 3000

TRANSPARENTNY transparent	MROŻONY frozen	MLECZNY milky	FROSTED MLECZNY milky frosted	CZARNY PMMA black PMMA	LENS 15 lens 15	LENS 30 lens 30
BASIC						
1 m/PMMA 11-2350-10 1 m/PC 11-3013-10	1 m/PMMA 11-2302-10 1 m/PC 11-3012-10	1 m/PMMA 11-2251-10 1 m/PC 11-3011-10	1 m/PMMA 11-2406-10	1 m/PMMA 11-2017-10	1 m/PMMA 11-2060-10	1 m/PMMA 11-2080-10

Zaślepki (aluminium i tworzywo sztuczne) / End caps (aluminum and plastic)

Z OTWOREM with a hole				BEZ OTWORU without a hole			
BIAŁY white	CZARNY black	INOX inox	SREBRNY / SZARY silver / gray	BIAŁY white	CZARNY black	INOX inox	SREBRNY / SZARY silver / gray
BASIC							
ABS 12-0091-00	ABS 12-0092-00	ABS 12-0093-00	ABS 12-0094-00	ABS 12-0091-01	ABS 12-0092-01	ABS 12-0093-01	ABS 12-0094-01
	ALU 12-0092-10		ALU 12-0095-10		ALU 12-0092-11		ALU 12-0095-11
			ABS lacq. 12-0000-48				ABS lacq. 12-0000-47

Dodatki / Accessories

TRANSPARENTNY, BIAŁY, CZARNY transparent, white, black	UCHWYT METALOWY Y metal mounting clip Y	ZAWIAS hinge	PROFIL MONTAŻOWY Y M1 assembly profile Y M1	WŁĄCZNIK BEZDOTYKOWY contactless switch	UCHWYT NA PRZEWÓD fi 5 mm cable fi 5 mm holder	ZAWIESIA pendants
	13-0083-00	14-6045-00	10-0654-10	14-7052-00	*T 14-7067-00 *B 14-7067-02	*S 14-2011-02 *B 14-2076-00 *W 14-2075-00

* S SREBRNY silver; * B CZARNY black; * T TRANSPARENTNY transparent; * W BIAŁY white

RECEPTION



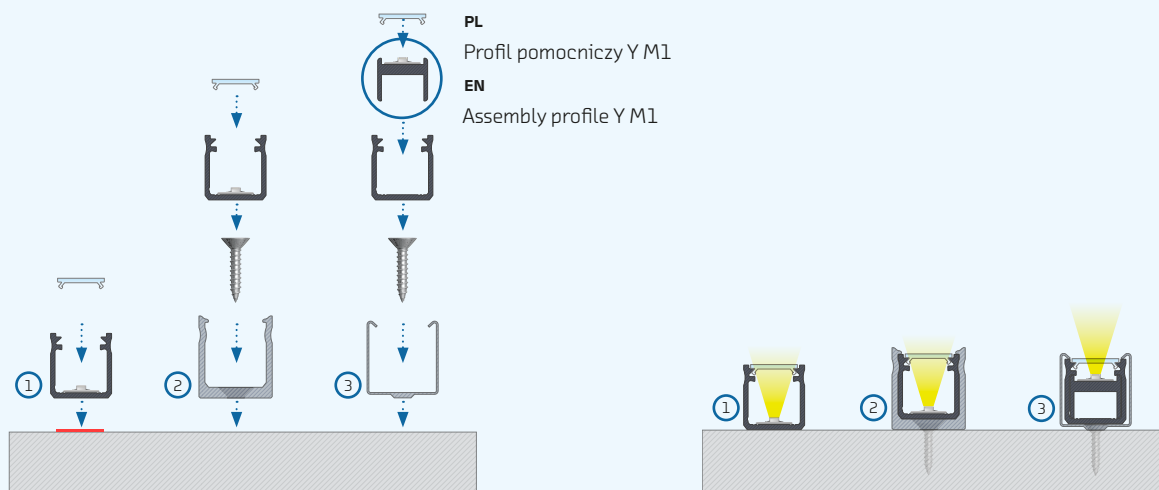

PL
Profil pomocniczy Y M1
EN
Assembly profile Y M1

PL
Instrukcja montażu profilu Y z kloszem BASIC za pomocą [1] taśmy dwustronnej, [2] uchwyty montażowego Y, [3] profilu pomocniczego Y M1 oraz uchwyty metalowego Y.

EN
Installation instructions for profile Y with a BASIC cover using [1] a double-sided tape, [2] a mounting clip Y, [3] an assembly profile Y M1 and a metal mounting clip Y.

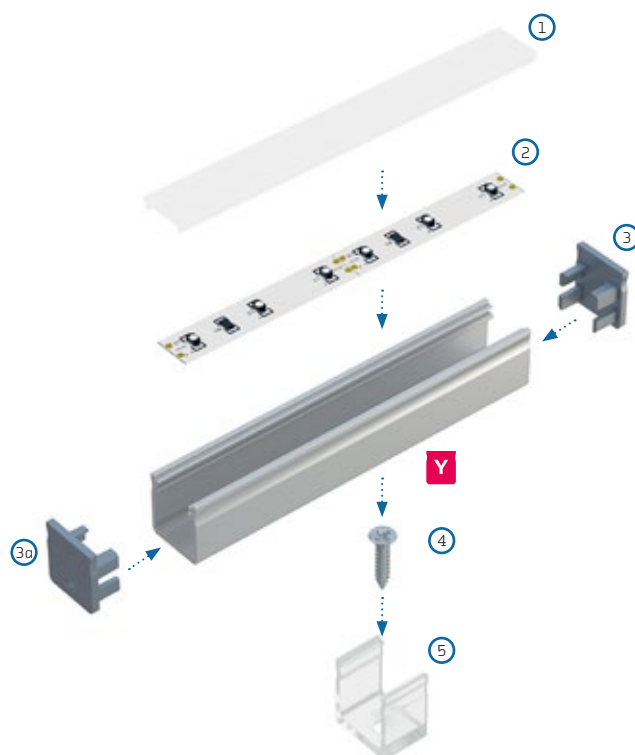

PL
Schemat złożenia elementów systemu oświetleniowego z wykorzystaniem profilu Y oraz [1] klosza BASIC, [2] taśmy LED, [3] zaślepki bez otworu, [3a] zaślepki z otworem, [4] wkrętu, [5] uchwyty montażowego Y.

EN
Assembly scheme for elements of the lighting system using profile Y and [1] a BASIC cover, [2] a LED strip, [3] an end cap without hole, [3a] an end cap with hole, [4] a mounting screw, [5] a mounting clip Y.

Z

Profil LED / Profile LED

PL

Profil wpuszczany – do oświetlenia pomieszczeń kuchennych, sklepowych – oświetlenie półek, blatów.

EN

Groove mounted profile – for lighting kitchens and stores – lighting for shelves, countertops.

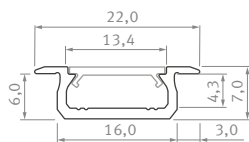

Sposoby montażu /
Assembly methods







Z

Z







Profil LED / Profile LED

Wymiary [mm] / Dimensions [mm]: 1000, 2020, 3000

	BIAŁY (lakierowany) white (lacquered)	CZARNY (anodowany) black (anodized)	INOX (anodowany) inox (anodized)	SREBRNY (anodowany) silver (anodized)	SUROWY raw
Kolory profili Profile colors					
1,0 m	10-0101-10	10-0102-10	10-0103-10	10-0104-10	10-0100-10
2,02 m	10-0101-20	10-0102-20	10-0103-20	10-0104-20	10-0100-20
3,0 m	10-0101-30	10-0102-30	10-0103-30	10-0104-30	10-0100-30
Szerokość taśmy LED (mm) LED strip width (mm)	do 12 up to 12				

Klosze (PVC/PMMA/PC) / Covers

Wymiary [mm] / Dimensions [mm]: 1000, 2020, 3000

TRANSPARENTNY transparent	MROŻONY frozen	MLECZNY milky	FROSTED MLECZNY milky frosted	CZARNY PMMA black PMMA	LENS 15 lens 15	LENS 30 lens 30
BASIC						
						
1 m/PMMA 11-2350-10 1 m/PC 11-3013-10	1 m/PMMA 11-2302-10 1 m/PC 11-3012-10	1 m/PMMA 11-2251-10 1 m/PC 11-3011-10	1 m/PMMA 11-2406-10	1 m/PMMA 11-2017-10	1 m/PMMA 11-2060-10	1 m/PMMA 11-2080-10

Zaślepki (aluminium i tworzywo sztuczne) / End caps (aluminum and plastic)

Z OTWOREM with a hole			
BIAŁY white	CZARNY black	INOX inox	SREBRNY / SZARY silver / gray
BASIC			
			
ABS 12-0101-00	ALU 12-0102-10 ABS 12-0102-00	ABS 12-0103-00	ALU 12-0105-10 ABS lacq. 12-0000-50 ABS 12-0104-00



Z
LUMINES

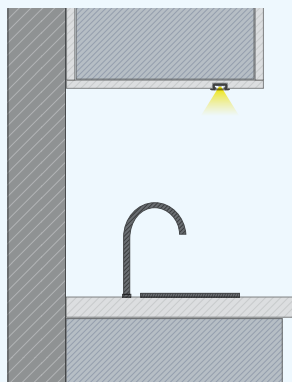

PL
Montaż profilu Z wewnątrz wyfrezowanego otworu nad blatem kuchennym.

EN
Installation of profile Z inside the milled groove over the Kitchen countertop.

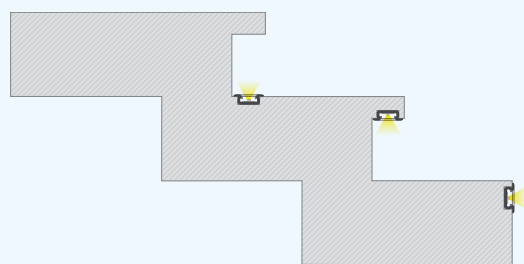

PL
Sposoby montażu profilu Z wewnątrz wyfrezowanych otworów na przykładzie schodów.

EN
Methods of installing profile Z inside milled groove using stairs as an example.



DUAL

Profil LED / Profile LED

PL
Profil nawierzchniowy, dwu taśmowy – do podświetlenia dekoracyjnego pomieszczeń biurowych oraz domowych.

EN
A surface profile, suitable for two rows of a LED strips – for decorative illumination of office and home spaces.

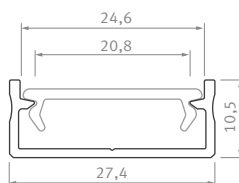

DUAL

Sposoby montażu /
Assembly methods

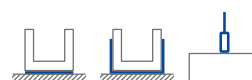





DUAL

DUAL

Profil LED / Profile LED

Wymiary [mm] / Dimensions (mm): 1000, 2020, 3000

	BIAŁY (lakierowany) white (lacquered)	CZARNY (anodowany) black (anodized)	INOX (anodowany) inox (anodized)	SREBRNY (anodowany) silver (anodized)	SUROWY raw
Kolory profili Profile colors					
1,0 m	10-0000-64	10-0000-69	10-0000-74	10-0000-78	10-0000-83
2,02 m	10-0000-65	10-0000-70	10-0000-75	10-0000-79	10-0000-84
3,0 m	10-0000-66	10-0000-71	10-0000-76	10-0000-80	10-0000-85
Szerokość taśmy LED (mm) LED strip width (mm)	2 × 10 mm				

Klosze (PMMA) / Covers



Wymiary [mm] / Dimensions (mm): 1000, 2020, 3000

TRANSPARENTNY transparent	MROŻONY frozen	MLECZNY milky	FROSTED MLECZNY milky frosted	CZARNY PMMA black PMMA
DOUBLE				
				
1 m/PMMA 11-2073-10	1 m/PMMA 11-2072-10	1 m/PMMA 11-2071-10	1 m/PMMA 11-2076-10	1 m/PMMA 11-2447-10

Zaślepki (tworzywo sztuczne) / End caps (plastic)

Z OTWOREM TRASOWANYM with push-hole			
BIAŁY white	CZARNY black	INOX inox	SREBRNY / SZARY silver / gray
BASIC			
			
ABS 12-0000-59	ABS 12-0000-60	ABS 12-0000-61	ABS lacq. 12-1095-01 ABS 12-0000-62

Dodatki / Accessories

UCHWYT DUAL METALOWY metal mounting clip DUAL	WŁĄCZNIK BEZDOTYKOWY contactless switch
	
13-0000-01	14-7052-00

DUAL
LUMINES



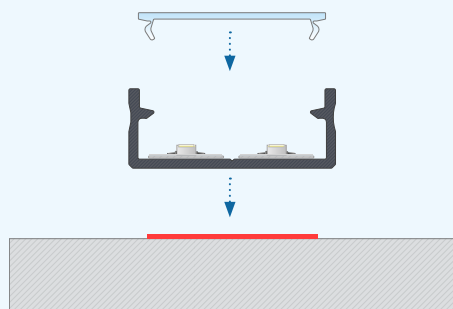

PL
Instrukcja montażu profilu DUAL z kloszem DOUBLE, z taśmą dwustronną.

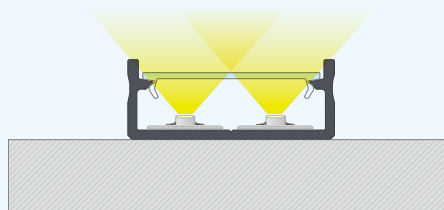

EN
Installation manual for DUAL profile with DOUBLE cover with double-sided tape.

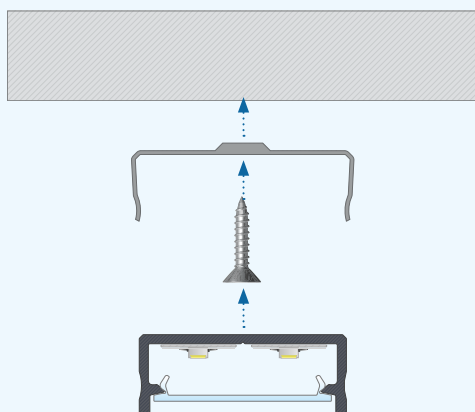

PL
Instrukcja montażu profilu DUAL z kloszem DOUBLE z uchwytem montażowym DUAL.

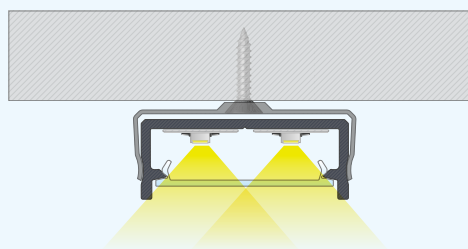

EN
Installation manual for DUAL profile with DOUBLE cover with a mounting clip for DUAL.



NEW
2023

GEMI

Profil LED / Profile LED

PL

Szeroki Profil LED do montażu w wyfrezowanych otworach. Pozwala na montaż dwóch równolegle ułożonych taśm LED.

EN

Wide LED profile for installation in milled openings. Enables the installation of two parallel LED strips.

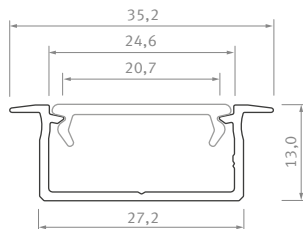

Sposoby montażu /
Assembly methods







GEMI

GEMI

Profil LED / Profile LED

Wymiary [mm] / Dimensions [mm]: 1000, 2020, 3000



	BIAŁY (lakierowany) white (lacquered)	CZARNY (anodowany) black (anodized)	SREBRNY (anodowany) silver (anodized)	SUROWY raw
Kolory profili Profile colors				
1,0 m	10-0991-10	10-1002-10	10-1014-10	10-1020-10
2,02 m	10-0991-20	10-1002-20	10-1014-20	10-1020-20
3,0 m	10-0991-30	10-1002-30	10-1014-30	10-1020-30
Szerokość taśmy LED (mm) LED strip width (mm)	2 × 10 mm			

Klosze (PMMA) / Covers

Wymiary [mm] / Dimensions [mm]: 1000, 2020, 3000

TRANSPARENTNY transparent	MROŻONY frozen	MLECZNY milky	FROSTED MLECZNY milky frosted	CZARNY PMMA black PMMA
DOUBLE				
				
1 m/PMMA 11-2073-10	1 m/PMMA 11-2072-10	1 m/PMMA 11-2071-10	1 m/PMMA 11-2076-10	1 m/PMMA 11-2447-10

Zaślepki (tworzywo sztuczne) / End caps (plastic)

Z OTWOREM with hole				
BIAŁY white	CZARNY black	SREBRNY silver	SZARY gray	
BASIC				
				
ABS 12-1051-00	ABS 12-1052-00	ABS lacq. 12-1055-01	ABS 12-1054-00	

Dodatki / Accessories

WŁĄCZNIK BEZDOTYKOWY
contactless switch



14-7052-00



GEMI
LUMINES

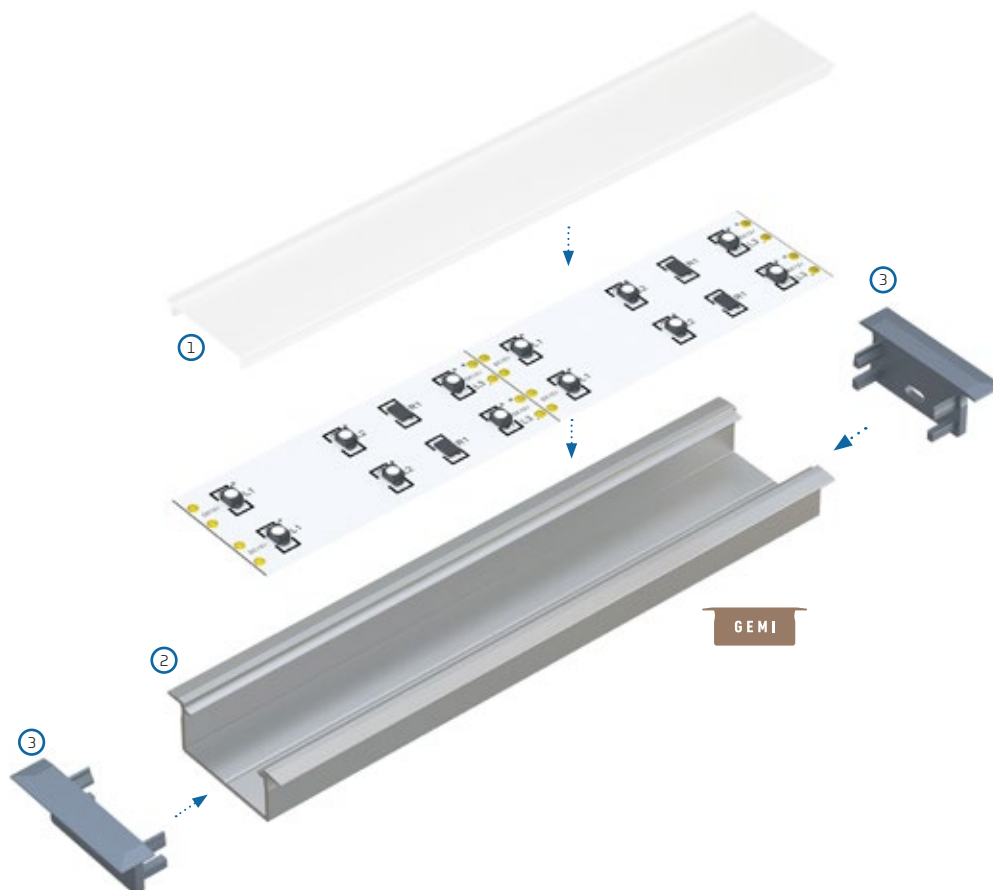

PL

Schemat złożenia elementów systemu oświetleniowego z wykorzystaniem profilu GEMI oraz (1) klosza DOUBLE, (2) 2 × taśmy LED, (3) zaślepek z otworami.

EN

Assembly schematic for the elements of the lighting system using recessed profile GEMI and (1) a DOUBLE cover, (2) a 2 × LED strip, (3) end caps with hole.

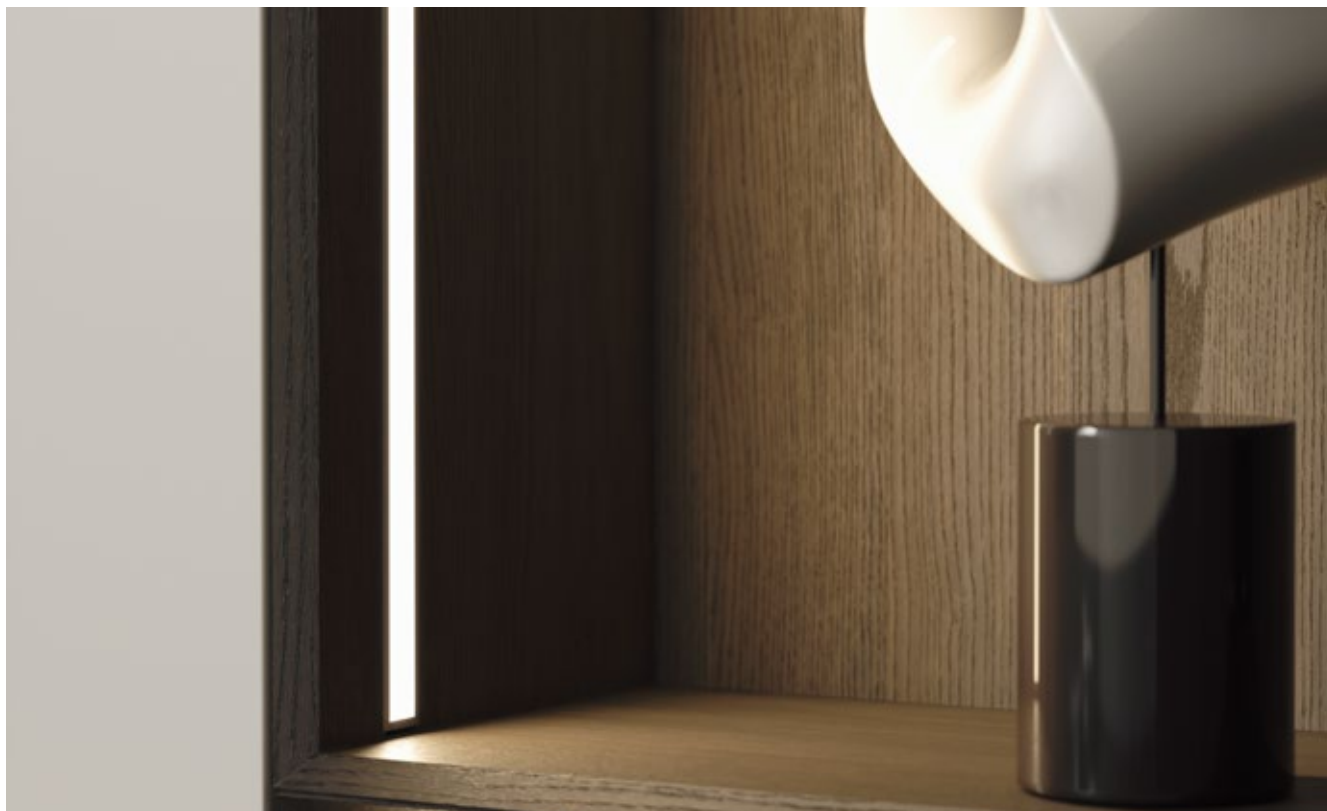

MICO

Profil LED / Profile LED

PL
Profil okrągły – do punktowego oświetlenia dekoracyjnego obrazów, witryn sklepowych, wystawowych.

EN
Round profile – for the spot decorative lighting of pictures, shop windows, exhibitions.

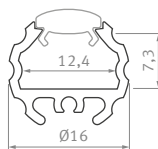

Sposoby montażu /
Assembly methods

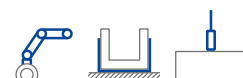

MICO



Profil LED / Profile LED

Wymiary [mm] / Dimensions (mm): 1000, 2020, 3000

	BIAŁY (lakierowany) white (lacquered)	CZARNY (anodowany) black (anodized)	INOX (anodowany) inox (anodized)	SREBRNY (anodowany) silver (anodized)	SUROWY raw
Kolory profili Profile colors					
1,0 m	10-0301-10	10-0302-10	10-0303-10	10-0304-10	10-0300-10
2,02 m	10-0301-20	10-0302-20	10-0303-20	10-0304-20	10-0300-20
3,0 m	10-0301-30	10-0302-30	10-0303-30	10-0304-30	10-0300-30
Szerokość taśmy LED (mm) LED strip width (mm)	do 10 up to 10				

Klosze (PVC/PMMA/PC) / Covers

Wymiary [mm] / Dimensions (mm): 1000, 2020, 3000

TRANSPARENTNY transparent	MROŻONY frozen	MLECZNY milky	FROSTED MLECZNY milky frosted	CZARNY PMMA black PMMA	SLIM LENS 15 slim lens 15
SLIM					
1 m/PMMA 11-2023-10	1 m/PMMA 11-2022-10	1 m/PMMA 11-2021-10	1 m/PMMA 11-2026-10	1 m/PMMA 11-2027-10	1 m/PMMA 11-2060-10

Zaślepki (aluminium i tworzywo sztuczne) / End caps (aluminum and plastic)

Z OTWOREM with a hole				BEZ OTWORU without a hole			
BIAŁY white	CZARNY black	INOX inox	SREBRNY / SZARY silver / gray	BIAŁY white	CZARNY black	INOX inox	SREBRNY / SZARY silver / gray
ABS 12-0981-00	ABS 12-0982-00	ABS 12-0983-00	ABS lacq. 12-0985-00 ABS 12-0984-00	ABS 12-0981-01	ABS 12-0982-01	ABS 12-0983-01	ABS lacq. 12-0985-01 ABS 12-0984-01
	ALU 12-0542-10		ALU 12-0545-10		ALU 12-0542-11		ALU 12-0545-11

Dodatki / Accessories

UCHWYT MICO METALOWY metal mounting clip MICO	PODSTAWKA hinge joint base	PRZEGUB ŻEŃSKI female hinge joint	PRZEGUB MĘSKI male hinge joint	ZAWIAS hinge	PROFIL POMOCNICZY METRO assembly profile METRO	ŚRUBA RADEŁKOWANA knurled screw
13-0150-02	14-6044-02	14-6044-04	14-6044-03	14-6045-00	10-0294-10	14-6044-06

LUMINES®
LIGHTING

MICO
LUMINES



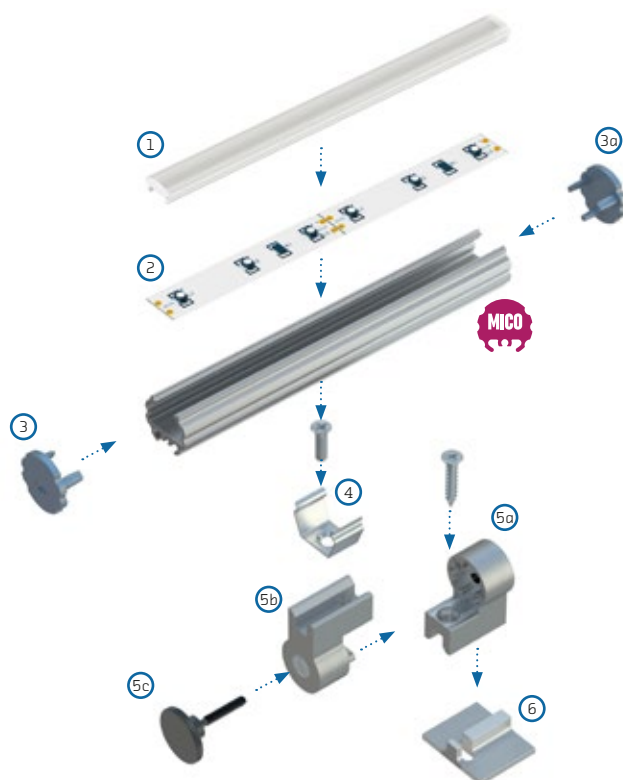

PL

Schemat złożenia elementów systemu oświetleniowego z wykorzystaniem profilu okrągłego MICO oraz (1) klosza SLIM LENS 15, (2) taśmy LED, (3) zaślepki z otworem, (3a) zaślepki bez otworu, (4) uchwytu montażowego MICO, (5a) elementu przegubu żeńskiego, (5b) elementu przegubu męskiego, (5c) śruby radetkowej, (6) podstawki.

EN

Assembly scheme for elements of the lighting system using round profile MICO and (1) a SLIM LENS cover, (2) a LED strip, (3) an end cap with hole, (3a) an end cap without hole, (4) a MICO mounting clip, (5a) female hinge joint, (5b) male hinge joint, (5c) knurled screw, (6) hinge joint base.

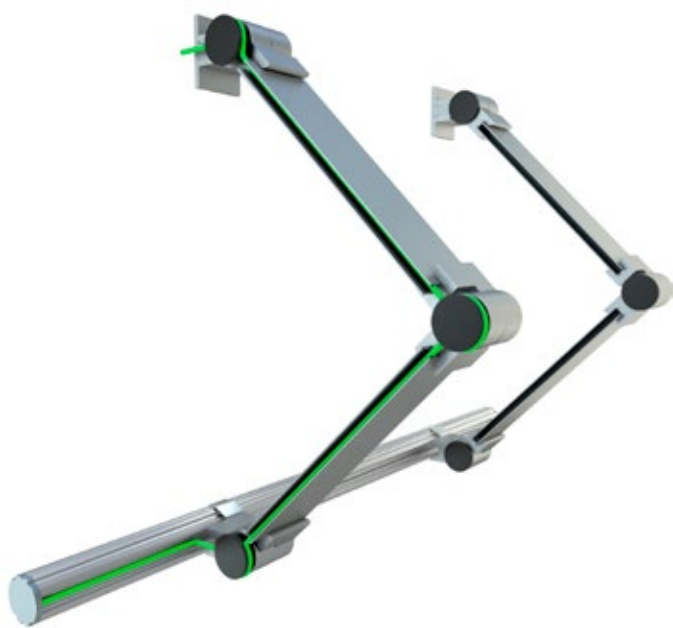

PL

Instrukcja prowadzenia przewodów zasilających w systemie przegubowym dla profilu MICO z wykorzystaniem profilu pomocniczego METRO.

EN

Instruction of hiding power supply wires using the rigid system for MICO profile, inside of assembly METRO profile.

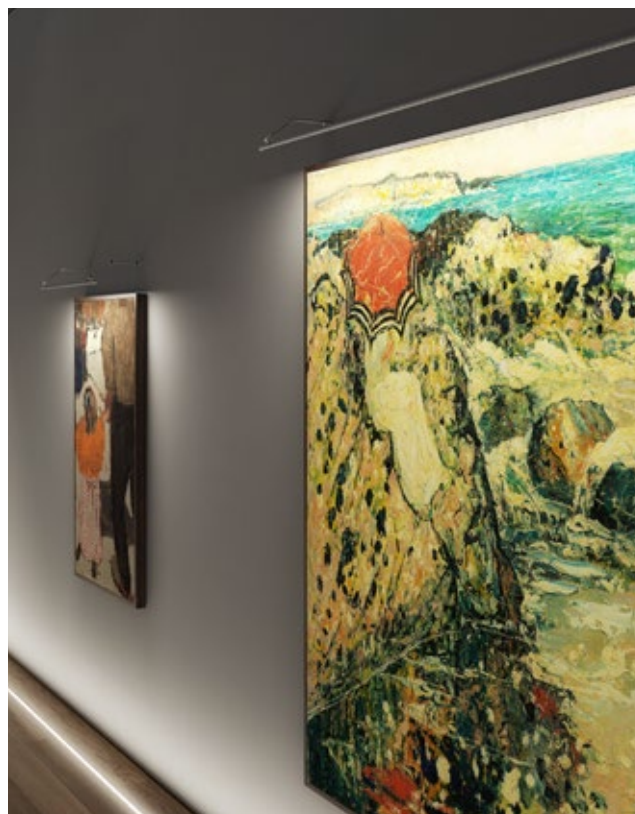



COSMO

Profil LED / Profile LED

PL
Profil okrągły/regulowany – do oświetlenia wnętrza szaf, zastępujący podstawową budowę drążka. Do oświetlenia dekoracyjnego i punktowego.

EN
Round / adjustable profile. For lighting the interior of closets - used instead of the basic construction of the closet bar. For the spot and decorative lighting.

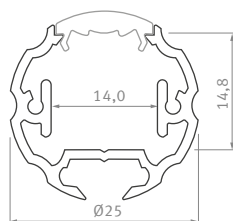

Sposoby montażu /
Assembly methods



COSMO



Profil LED / Profile LED

Wymiary [mm] / Dimensions (mm): 1000, 2020, 3000

	BIAŁY (lakierowany) white (lacquered)	CZARNY (anodowany) black (anodized)	INOX (anodowany) inox (anodized)	SREBRNY (anodowany) silver (anodized)	SUROWY raw
Kolory profili Profile colors					
1,0 m	10-0171-10	10-0172-10	10-0173-10	10-0174-10	10-0170-10
2,02 m	10-0171-20	10-0172-20	10-0173-20	10-0174-20	10-0170-20
3,0 m	10-0171-30	10-0172-30	10-0173-30	10-0174-30	10-0170-30
Szerokość taśmy LED [mm] LED strip width (mm)	do 12 up to 12				

Klosze (PVC/PMMA/PC) / Covers

Wymiary [mm] / Dimensions (mm): 1000, 2020, 3000

TRANSPARENTNY transparent	MROŻONY frozen	MLECZNY milky	FROSTED MLECZNY milky frosted	CZARNY PMMA black PMMA	LENS 15 lens 15	LENS 30 lens 30
BASIC						
1 m/PMMA 11-2350-10 1 m/PC 11-3013-10	1 m/PMMA 11-2302-10 1 m/PC 11-3012-10	1 m/PMMA 11-2251-10 1 m/PC 11-3011-10	1 m/PMMA 11-2406-10	1 m/PMMA 11-2017-10	1 m/PMMA 11-2060-10	1 m/PMMA 11-2080-10

Zaślepki (aluminium i tworzywo sztuczne) / End caps (aluminum and plastic)

CZARNY black	SREBRNY silver	CZARNY black	SREBRNY silver	BIAŁY white	CZARNY black	INOX inox	SREBRNY / SZARY silver / gray
Z OTWOREM with a hole		BEZ OTWORU without a hole		Z OTWOREM TRASOWANYM with push-hole			
ALU 12-0172-10	ALU 12-0175-10	ALU 12-0172-11	ALU 12-0175-11	ABS 12-0921-01	ABS 12-0922-01	ABS 12-0923-01	ABS lacq.12-0925-01 ABS 12-0924-01
REGULACYJNA Z OTWOREM adjustment cap with hole		REGULACYJNA BEZ OTWORU adjustment cap without hole		REGULACYJNA adjusting ring			
ALU 12-0182-10	ALU 12-0185-10	ALU 12-0182-11	ALU 12-0185-11	ALU 14-5042-02		ALU 14-5042-04	

Dodatki / Accessories

UCHWYT COSMO METALOWY metal mounting clip COSMO	PODSTAWKA hinge joint base	PRZEGUB ŻEŃSKI female hinge joint	PRZEGUB MĘSKI male hinge joint	ZAWIAS hinge	PROFIL POMOCNICZY METRO assembly profile METRO	PROFIL MONTAŻOWY COSMO M1 mounting profile COSMO M1	ŚRUBA RADEŁKOWANA knurled screw
13-0130-02	14-6044-02	14-6044-04	14-6044-03	14-6045-00	10-0294-10	10-0164-10	14-6044-06
ROZETA - KOŁNIERZ CHROM Ø 25 MM BASIC collar Ø 25 mm chrome	ROZETA - WYSOKA PEŁNA HIGH collar - full end	ROZETA - WYSOKA PRZELOTOWA HIGH collar - with hole	ROZETA - NISKA PEŁNA LOW collar - full end	ROZETA - NISKA PRZELOTOWA LOW collar - with hole	ŁĄCZNIK KĄTOWY 120° angular connector 120°	ŁĄCZNIK KĄTOWY 90° angular connector 90°	ŁĄCZNIK PROSTY straight connector
14-5043-00	14-5047-01	14-5047-02	14-5043-01	14-5043-02	14-3036-01	14-3030-01	14-3032-02



COSMO
LUMINES

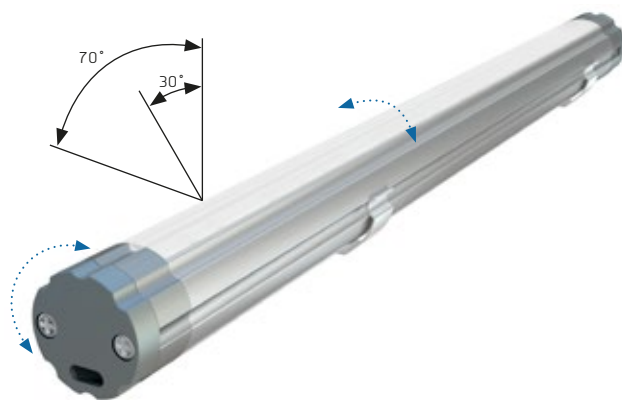

PL

Złożenie profilu COSMO z kloszem BASIC LENS 30, uchwytami, zaślepkami oraz pierścieniem regulacyjnym.

EN

Assembly of profile COSMO with BASIC LENS 30 cover, mounting clips, end caps and adjusting ring.

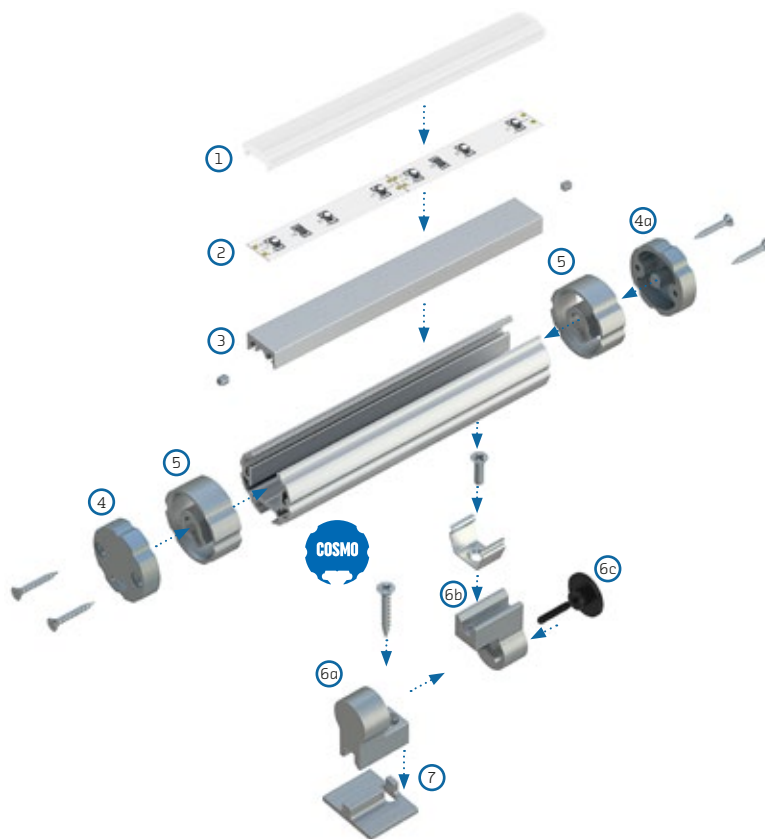

PL

Schemat złożenia elementów systemu oświetleniowego z wykorzystaniem profilu okrągłego COSMO oraz [1] klosza BASIC LENS 30, [2] taśmy LED, [3] profilu COSMO M1, [4] zaślepki regulacyjnej z otworem, [4a] zaślepki regulacyjnej bez otworu, [5] pierścieni regulacyjnych, [6a] elementu przegubu żeńskiego, [6b] elementu przegubu męskiego, [6c] śruby radetkowej, [7] podstawki.

EN

Assembly scheme of the lighting system using COSMO round profile and [1] a BASIC LENS 30 cover, [2] a LED strip, [3] a COSMO M1 assembly profile, [4] an adjusting end cap with hole, [4a] an adjusting end cap without hole, [5] adjusting rings, [6a] female hinge joint, [6b] male hinge joint, [6c] knurled screw, [7] hinge joint base.



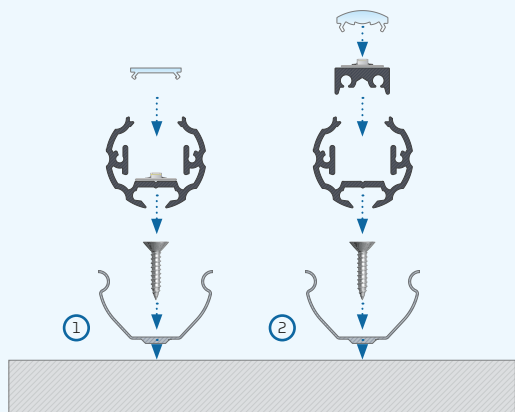

PL
Instrukcja montażu profilu okrągłego COSMO z (1) kloszem BASIC, (2) kloszem BASIC LENS 30 z wykorzystaniem profilu pomocniczego COSMO M1 oraz uchwyty montażowego metalowego COSMO.

EN
Instruction of assembly of the round COSMO profile with (1) a BASIC cover, (2) a BASIC LENS 30 cover using an assembly profile COSMO M1 and a COSMO metal mounting clip.

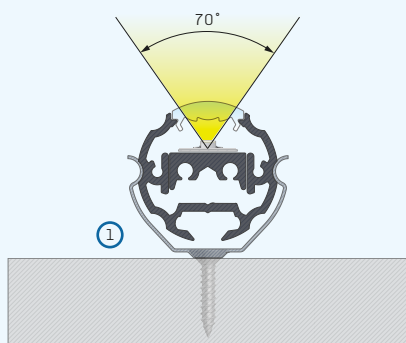

PL
Przykład zastosowania profilu pomocniczego COSMO M1 zmieniającego kąt świecenia taśmy LED - (1) położenie górne, (2) położenie dolne.

EN
Example of using the assembly profile COSMO M1, which changes the beam angle - (1) LED strip on the top, (2) LED strip at the bottom.

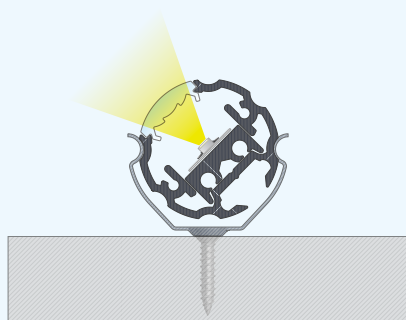

PL
Przykład zmiany położenia o 45° profilu COSMO przy wykorzystaniu uchwyty montażowego metalowego COSMO.

EN
Example of changing the position by 45 degrees of COSMO profile by moving the profile inside of the metal COSMO mounting clip.

RETO

Profil LED / Profile LED

PL
Profil nawierzchniowy z możliwością regulowania kąta świecenia, przy zastosowaniu różnych zaślepek końcowych. Do stosowania w kuchni i pomieszczeniach domowych.

EN
Surface profile with the possibility to adjust the lighting angle, using various end caps. To be used in the kitchen and household compartments.

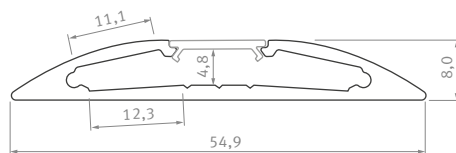

RETO

Sposoby montażu /
Assembly methods

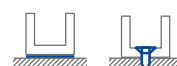





RETO

RETO







Profil LED / Profile LED

Wymiary [mm] / Dimensions (mm): 1000, 2020, 3000

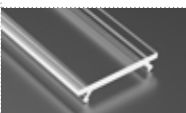
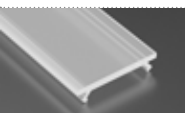

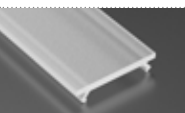













	BIAŁY (lakierowany) white (lacquered)	CZARNY (anodowany) black (anodized)	INOX (anodowany) inox (anodized)	SREBRNY (anodowany) silver (anodized)	SUROWY raw
Kolory profili Profile colors					
1,0 m	10-0521-10	10-0522-10	10-0523-10	10-0524-10	10-0520-10
2,02 m	10-0521-20	10-0522-20	10-0523-20	10-0524-20	10-0520-20
3,0 m	10-0521-30	10-0522-20	10-0523-30	10-0524-30	10-0520-30
Szerokość taśmy LED (mm) LED strip width (mm)	2 × 10				

Klosze (PVC/PMMA/PC) / Covers

Wymiary [mm] / Dimensions (mm): 1000, 2020, 3000

TRANSPARENTNY transparent	MROŻONY frozen	MLECZNY milky	FROSTED MLECZNY milky frosted	CZARNY PMMA black PMMA	LENS 15 lens 15	LENS 30 lens 30
BASIC						
						
1 m/PMMA 11-2350-10 1 m/PC 11-3013-10	1 m/PMMA 11-2302-10 1 m/PC 11-3012-10	1 m/PMMA 11-2251-10 1 m/PC 11-3011-10	1 m/PMMA 11-2406-10	1 m/PMMA 11-2017-10	1 m/PMMA 11-2060-10	1 m/PMMA 11-2080-10

Zaślepki (aluminium i tworzywo sztuczne) / End caps (aluminum and plastic)

	Z OTWOREM with a hole		BEZ OTWORU without a hole		Z OTWOREM TRASOWANYM with push-hole			
	CZARNY black	SREBRNY silver	CZARNY black	SREBRNY silver	BIAŁY white	CZARNY black	INOX inox	SREBRNY / SZARY silver / gray
0°								
	ALU 12-0572-10	ALU 12-0575-10	ALU 12-0572-11	ALU 12-0575-11	ABS 12-0991-01	ABS 12-0992-01	ABS 12-0993-01	ABS lacq. 12-0995-01 ABS 12-0994-01
	Z PODPORĄ with support							
					PRAWA right	LEWA left		
15°								
	ALU 12-0585-10 ALU 12-0595-10		ALU 12-0585-11 ALU 12-0595-11					
30°								
	ALU 12-0605-10 ALU 12-0615-10		ALU 12-0605-11 ALU 12-0615-11					



RETO
LUMINES

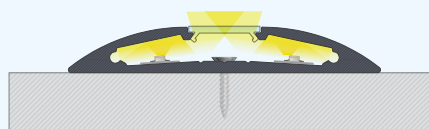
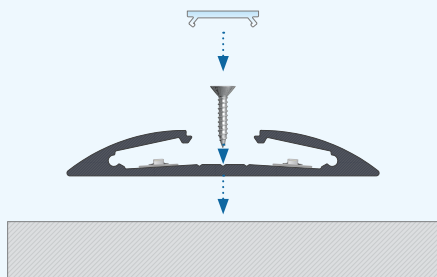

PL
Instrukcja montażu profilu RETO z kloszem BASIC za pomocą wkrętu montażowego.

EN
Installation instruction for profile RETO with a BASIC cover using mounting screw.

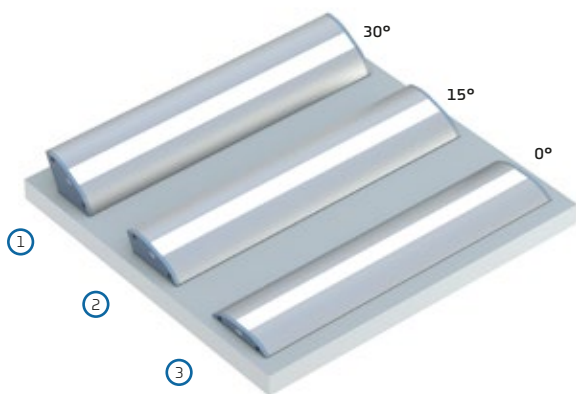

PL
Montaż profilu RETO z wykorzystaniem (1) zaślepek pod kątem 30°, (2) zaślepek pod kątem 15°, (3) zaślepek pod kątem 0°.

EN
Installation of RETO profile using (1) end caps at 30 degrees, (2) end caps at 15 degrees, (3) end caps at 0 degrees.





TERRA

Profil LED / Profile LED

PL

Płytki profil wpuszczany do montażu w podłodze. Oświetlenie dekoracyjne do biur, hoteli, łazienek.

EN

Groove mounted profile – floor lighting, decorative – bathrooms, offices, hotels.

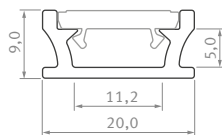

TERRA

Sposoby montażu /
Assembly methods





TERRA

TERRA

Profil LED / Profile LED

Wymiary [mm] / Dimensions (mm): 1000, 2020, 3000

	BIAŁY (lakierowany) white (lacquered)	CZARNY (lakierowany) black (lacquered)	SREBRNY (anodowany) silver (anodized)
Kolory profili Profile colors			
1,0 m	10-0151-10	10-0000-50	10-0154-10
2,02 m	10-0151-20	10-0000-51	10-0154-20
3,0 m	10-0151-30	10-0155-30	10-0154-30
Szerokość taśmy LED (mm) LED strip width (mm)	10 mm		







Klosze (PC) / Covers

Wymiary [mm] / Dimensions (mm): 1000, 2020, 3000

MLECZNY PC milky
TERRA

1 m/PC 11-3041-10

Zaślepki (aluminium i tworzywo sztuczne) / End caps (aluminum and plastic)

Z OTWOREM with a hole			BEZ OTWORU without a hole		
BIAŁY white	CZARNY black	SREBRNY / SZARY silver / gray	BIAŁY white	CZARNY black	SREBRNY / SZARY silver / gray
					
ABS 12-0141-00	ABS 12-0142-00	ALU 12-0145-10 ABS lacq. 12-0145-00 ABS 12-0144-00	ABS 12-0141-01	ABS 12-0142-01	ALU 12-0145-11 ABS lacq. 12-0145-01 ABS 12-0144-01



TERRA
LUMINES

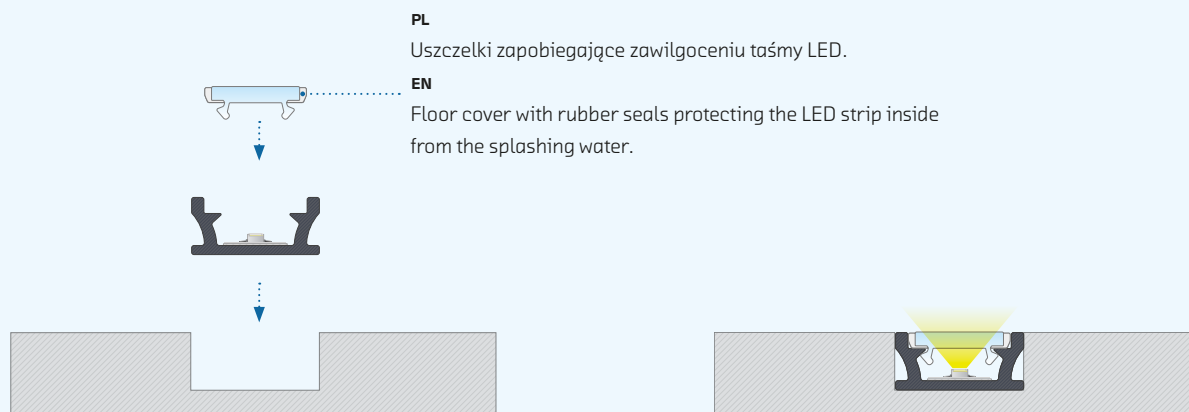

PL
Uszczelki zapobiegające zawilgoceniu taśmy LED.

EN
Floor cover with rubber seals protecting the LED strip inside from the splashing water.

PL
Instrukcja montażu profilu TERRA z kloszem podłogowym.

EN
Installation instruction for the TERRA profile with a floor cover.



PL
Schemat złożenia elementów systemu oświetleniowego z wykorzystaniem profilu TERRA oraz (1) klosza podłogowego, (2) taśmy LED, (3) zaślepki bez otworu, (3a) zaślepki z otworem.

EN
Assembly scheme for the elements of the lighting system using TERRA profile and (1) a floor cover, (2) a LED strip, (3) an end cap without hole, (3a) an end cap with hole.

RUNO

Profil LED / Profile LED

PL
Głęboki profil wpuszczany do montażu w podłodze. Oświetlenie dekoracyjne do biur, hoteli, łazienek.

EN
Groove mounted profile – floor lighting, decorative – bathrooms, offices, hotels.

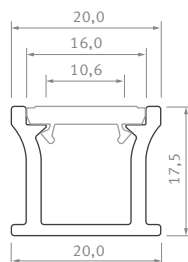

Sposoby montażu /
Assembly methods





RUNO



Profil LED / Profile LED

Wymiary [mm] / Dimensions (mm): 1000, 2020, 3000

	BIAŁY (lakierowany) white (lacquered)	CZARNY (lakierowany) black (lacquered)	SREBRNY (anodowany) silver (anodized)
Kolory profili Profile colors			
1,0 m	10-0001-37	10-0755-10	10-0001-42
2,02 m	10-0001-38	10-0625-20	10-0001-43
3,0 m	10-0001-39	10-0755-30	10-0001-44
Szerokość taśmy LED [mm] LED strip width (mm)	10 mm		

Klosze (PC) / Covers

Wymiary [mm] / Dimensions (mm): 1000, 2020, 3000

MLECZNY PC milky
TERRA

1 m/PC 11-3041-10

Zaślepki (tworzywo sztuczne) / End caps (plastic)

Z OTWOREM TRASOWANYM with push-hole		
BIAŁY white	CZARNY black	SREBRNY / SZARY silver / gray
		
ABS 12-0000-57	ABS 12-0000-71	ABS 12-0000-58 ABS lacq. 12-1105-01

LUMINES[®]
LIGHTING



RUNO
LUMINES

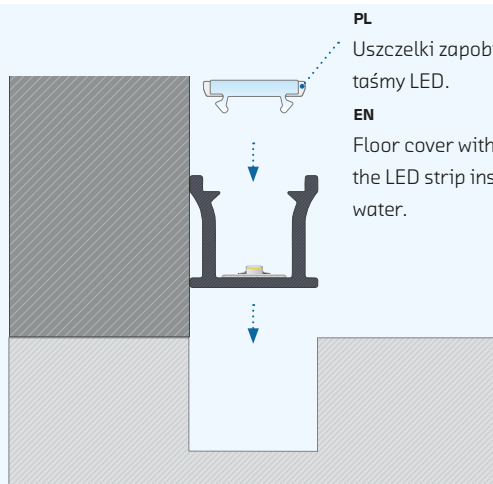

PL
Uszczelki zapobiegające zawilgoceniu taśmy LED.

EN
Floor cover with rubber seals protecting the LED strip inside from the splashing water.

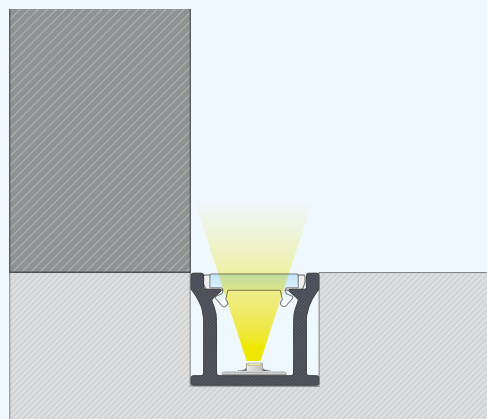

PL
Instrukcja montażu profilu RUNO z kloszem podłogowym.

EN
Installation instruction for the RUNO profile with a floor cover.

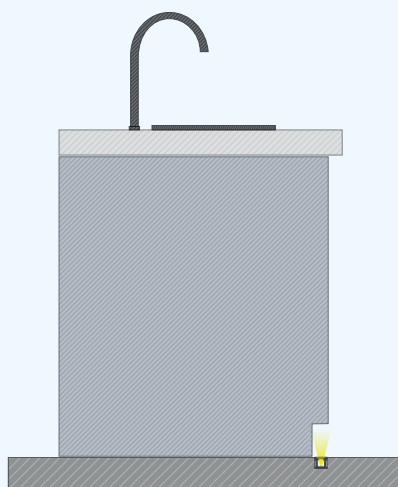

PL
Montaż profilu RUNO wewnątrz wyfrezowanego otworu.

EN
Installation of profile RUNO inside the milled groove.

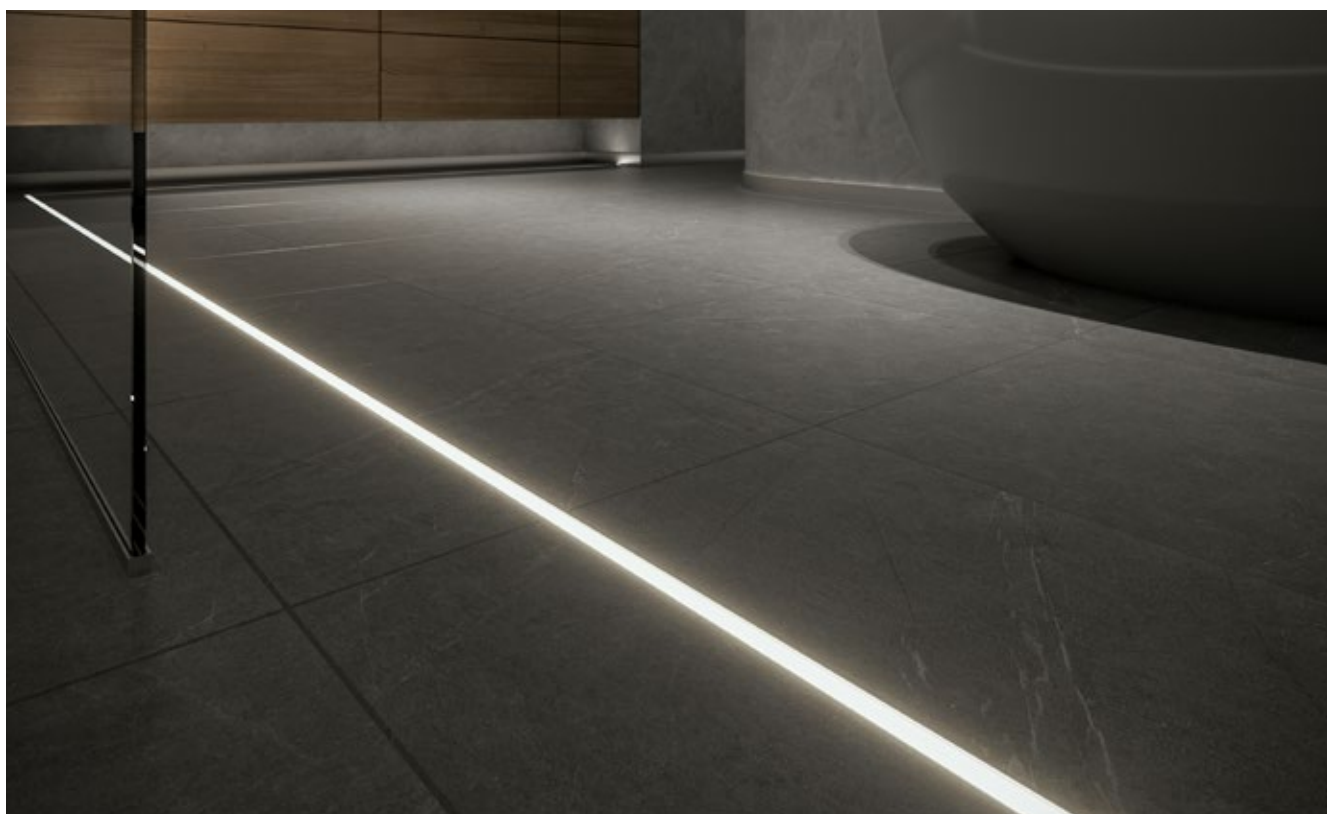

SCALA

Profil LED / Profile LED

PL
Profil schodowy z wmontowanym sznurem antypoślizgowym
– do oświetlenia schodów w przestrzeni publicznej.

EN
Stairs profile with built-in anti-slippery rope. To be used for
lighting of stairs in public spaces.

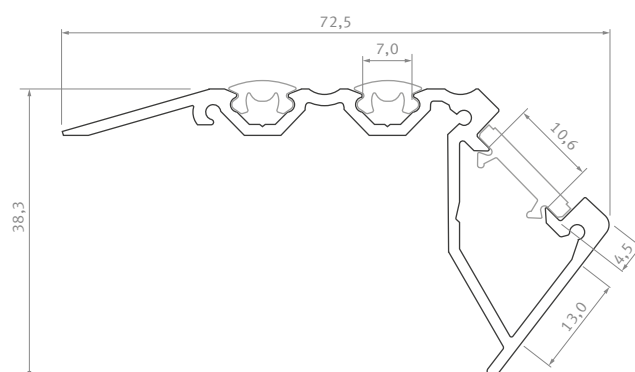

Sposoby montażu /
Assembly methods



SCALA



Profil LED / Profile LED

Wymiary [mm] / Dimensions (mm): 1000, 2020, 3000

Kolory profili Profile colors	CZARNY (anodowany) black (anodized)	SREBRNY (anodowany) silver (anodized)
		
	1,0 m 2,02 m 3,0 m	10-0322-10 10-0322-20 10-0322-30
Szerokość taśmy LED [mm] LED strip width [mm]	4 × 12	

Klosze (PC) / Covers

Wymiary [mm] / Dimensions (mm): 1000, 2020, 3000

MLECZNY PC milky
TERRA

1 m/PC 11-3041-10

Dodatki / Accessories

SZNUR ANTYPOŚLIZGOWY ANTI anti-slippery rope

14-5031-01

Zasłepki (aluminium) / End caps (aluminum)

Z OTWOREM with a hole				BEZ OTWORU without a hole			
SREBRNY silver		CZARNY black		SREBRNY silver		CZARNY black	
LEWA left	PRAWA right	LEWA left	PRAWA right	LEWA left	PRAWA right	LEWA left	PRAWA right
							
ALU 12-0625-10	ALU 12-0635-10	ALU 12-0622-10	ALU 12-0632-10	ALU 12-0625-11	ALU 12-0635-11	ALU 12-0622-11	ALU 12-0632-11

SCALA
LUMINES[®]

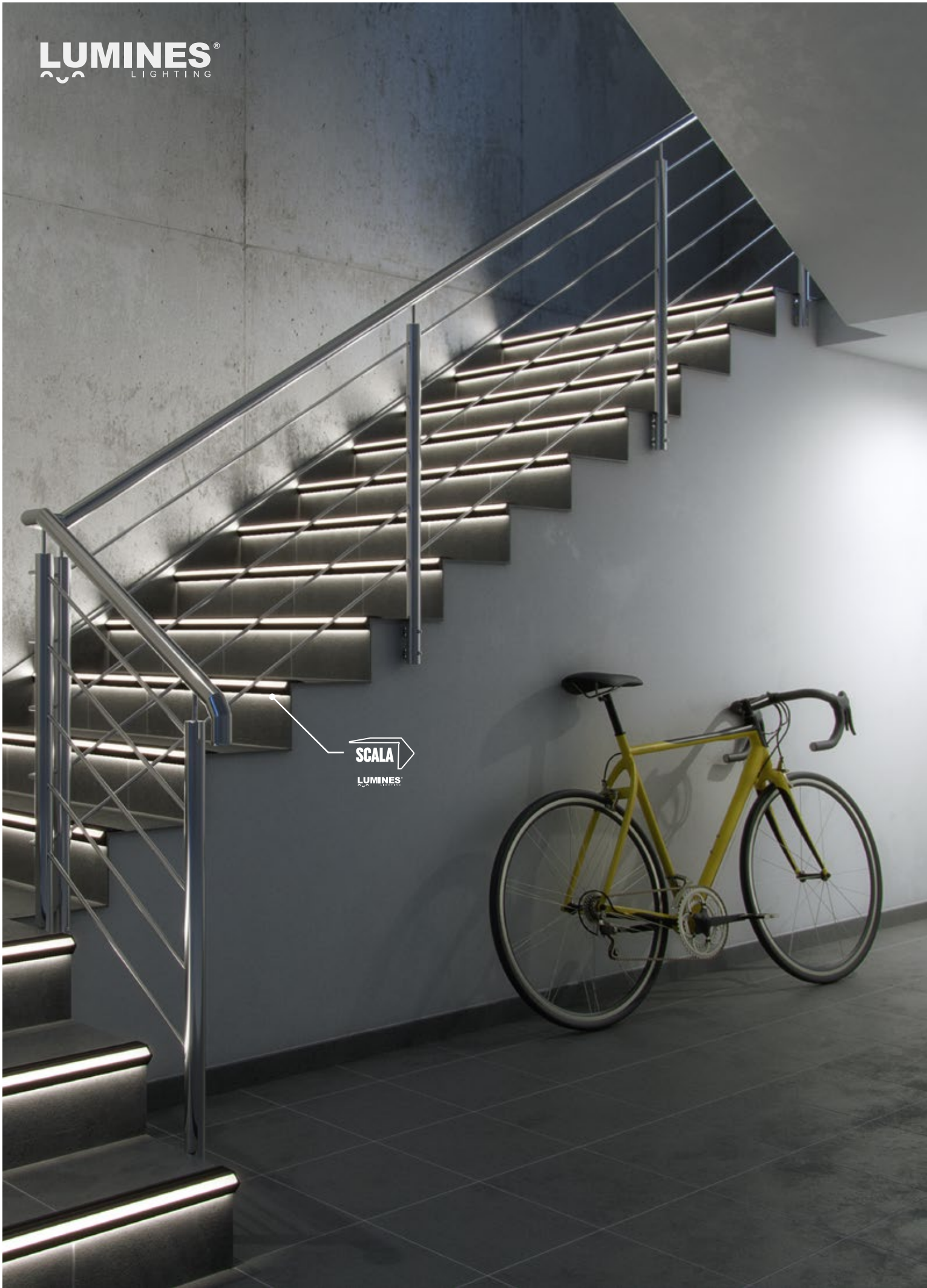

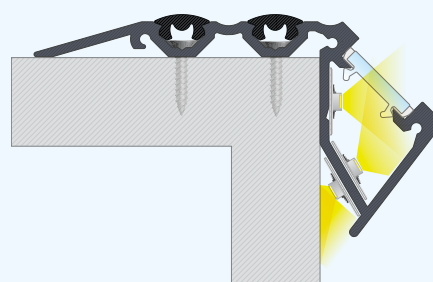
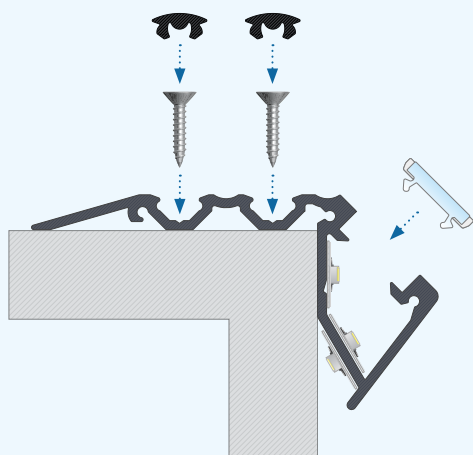

PL
Instrukcja montażu profilu schodowego SCALA z kloszem TERRA oraz sznurem antypoślizgowym ANTI.

EN
Instruction of the assembly of SCALA stair profile with TERRA cover and anti-slippery rope.

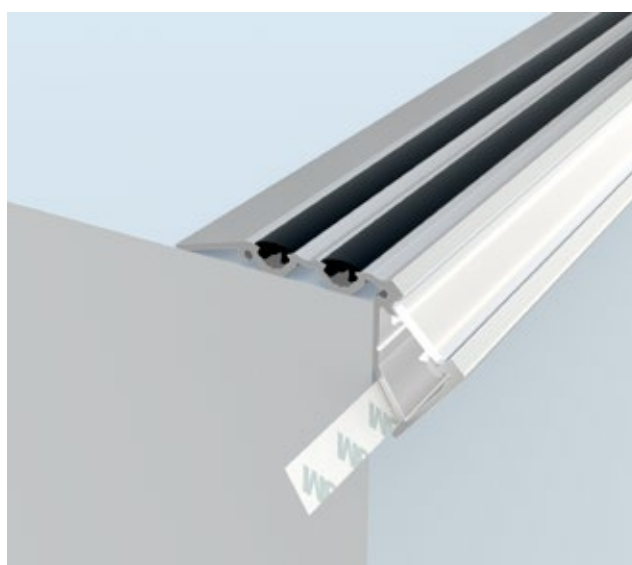
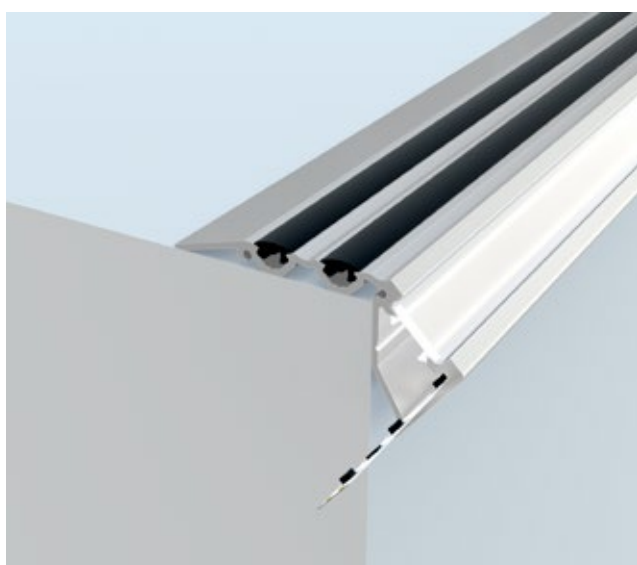
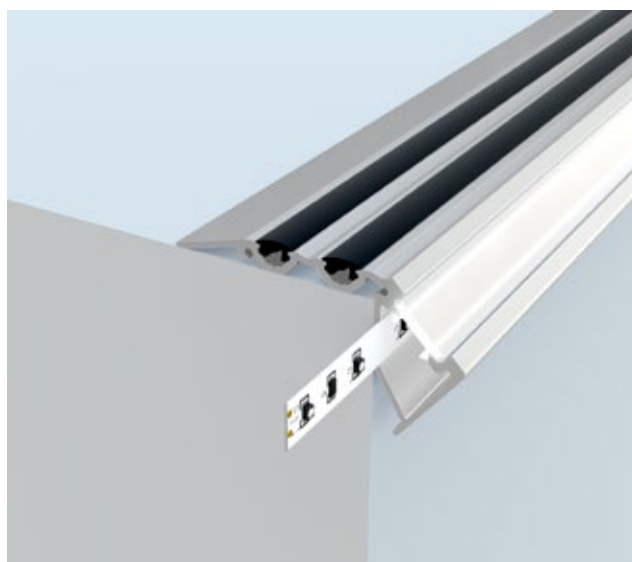

PL
Przykład sposobu montażu taśmy LED w profilu SCALA.

EN
Example of LED strip assembly inside of profile SCALA.

SILEDA

Profil LED / Profile LED

PL
Profil nawierzchniowy, dwu taśmowy.

EN
Two LED strips surface mounted profile spaces.

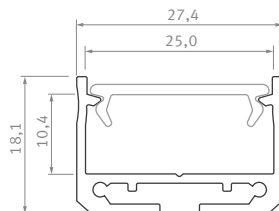

Sposoby montażu /
Assembly methods

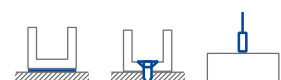

SILEDA



Profil LED / Profile LED

Wymiary [mm] / Dimensions (mm): 1000, 2020, 3000

	BIAŁY (lakierowany) white (lacquered)	CZARNY (lakierowany) black (lacquered)	SREBRNY (anodowany) silver (anodized)
Kolory profili Profile colors			
1,0 m	10-0331-10	10-0335-10	10-0334-10
2,02 m	10-0331-20	10-0335-20	10-0334-20
3,0 m	10-0331-30	10-0335-30	10-0334-30
Szerokość taśmy LED (mm) LED strip width (mm)	2 x 12		

Klosze (PMMA) / Covers

Wymiary [mm] / Dimensions (mm): 1000, 2020, 3000

TRANSPARENTNY transparent	MROŻONY frozen	MLECZNY milky	FROSTED MLECZNY milky frosted	CZARNY PMMA black PMMA
DOUBLE				
1 m/PMMA 11-2073-10	1 m/PMMA 11-2072-10	1 m/PMMA 11-2071-10	1 m/PMMA 11-2076-10	1 m/PMMA 11-2447-10

Zaślepki (aluminium i tworzywo sztuczne) / End caps (aluminum and plastic)

Z OTWOREM with a hole			BEZ OTWORU without a hole		
BIAŁY white	CZARNY black	SREBRNY silver	BIAŁY white	CZARNY black	SREBRNY silver
ALU 12-0641-10	ALU 12-0000-21	ALU 12-0645-10	ALU 12-0641-11	ALU 12-0000-19	ALU 12-0645-11
Z OTWOREM TRASOWANYM with push-hole					
BIAŁY white	CZARNY black	SREBRNY / SZARY silver / gray			
ABS 12-1001-01	ABS 12-1002-01	ABS lacq. 12-1005-01 ABS 12-1004-01			

Dodatki / Accessories

UCHWYT SILEDA METALOWY metal mounting clip SILEDA	WŁĄCZNIK BEZDOTYKOWY contactless switch	PODSTAWKA hinge joint base	PRZEGUB ŻEŃSKI female hinge joint	PRZEGUB MĘSKI male hinge joint	ZAWIAS hinge
13-0000-02	14-7052-00	14-6044-02	14-6044-04	14-6044-03	14-6045-00
ŁĄCZNIK PROSTY straight connector	ŁĄCZNIK KĄTOWY 90° angular connector 90°	ŁĄCZNIK POPRZECZNY KĄTOWY angular transverse connector	ŁĄCZNIK KĄTOWY 120° angular connector 120°	UCHWYT NA PRZEWÓD fi 5 mm cable fi 5 mm holder	ZAWIESIA pendants
14-3032-02	14-3030-01	14-3038-01	14-3036-01	*T 14-7067-00 *B 14-7067-02	*S 14-2011-02 *B 14-2076-00 *W 14-2075-00

* S SREBRNY silver; * B CZARNY black; * T TRANSPARENTNY transparent; * W BIAŁY white



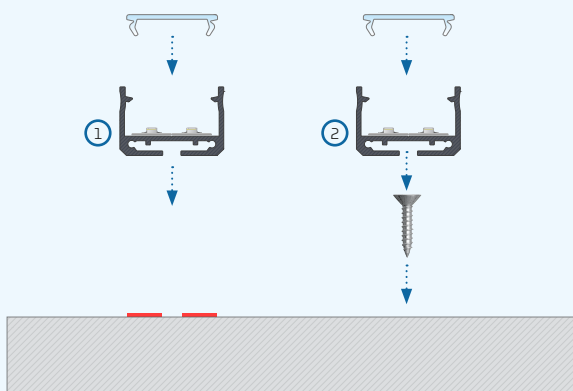

PL
Instrukcja montażu profilu SILEDA z kloszem DOUBLE z wykorzystaniem (1) taśmy dwustronnej, (2) wkrętu montażowego.

EN
Instruction of the assembly of SILEDA profile with DOUBLE cover using (1) double-sided tape, (2) mounting screw.

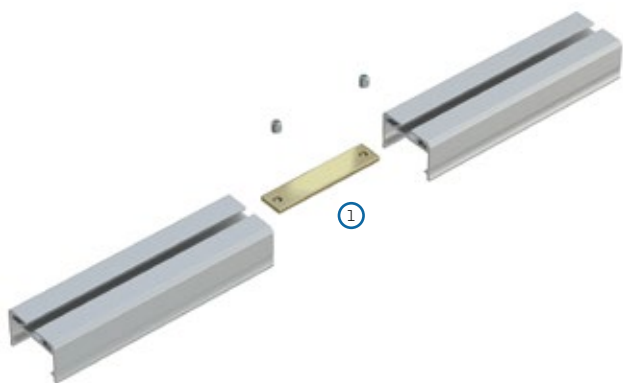

PL
Łączenie profili SILEDA za pomocą (1) łącznika prostego i (2) łącznika kątownego.

EN
Connecting profiles SILEDA using (1) straight connector and (2) angular connector.



inSILEDA

Profil LED / Profile LED

PL
Profil wpuszczany, architektoniczny – do stosowania sufitowego i ściennego w wyfrezowanym otworze.

EN
Recessed architectural profile – to be used in ceilings and walls in the milled groove.

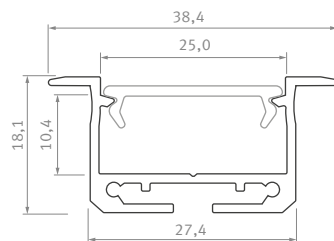

Sposoby montażu /
Assembly methods

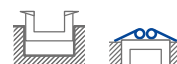



inSILEDA

inSILEDA

Profil LED / Profile LED

Wymiary [mm] / Dimensions [mm]: 1000, 2020, 3000

	BIAŁY (lakierowany) white (lacquered)	CZARNY (lakierowany) black (lacquered)	SREBRNY (anodowany) silver (anodized)
Kolory profili Profile colors			
1,0 m	10-0221-10	10-0225-10	10-0224-10
2,02 m	10-0221-20	10-0225-20	10-0224-20
3,0 m	10-0221-30	10-0225-30	10-0224-30
Szerokość taśmy LED [mm] LED strip width [mm]	2 × 12		

Klosze (PMMA) / Covers







Wymiary [mm] / Dimensions [mm]: 1000, 2020, 3000

TRANSPARENTNY transparent	MROŻONY frozen	MLECZNY milky	FROSTED MLECZNY milky frosted	CZARNY PMMA black PMMA
DOUBLE				
				
1 m/PMMA 11-2073-10	1 m/PMMA 11-2072-10	1 m/PMMA 11-2071-10	1 m/PMMA 11-2076-10	1 m/PMMA 11-2447-10

Zaślepki (aluminium i tworzywo sztuczne) / End caps (aluminum and plastic)

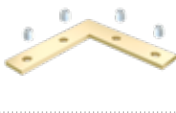
Z OTWOREM with a hole		
BIAŁY white	CZARNY black	SREBRNY / SZARY silver / gray
		
ALU 12-0411-10 ABS 12-0971-00	ALU 12-0000-11 ABS 12-1172-00	ALU 12-0415-10 ABS lacq. 12-0975-00 ABS 12-0974-00

Dodatki / Accessories

SPRĘŻYNY MONTAŻOWE mounting springs	ŁĄCZNIK PROSTY straight connector	ŁĄCZNIK KĄTOWY 90° angular connector 90°	ŁĄCZNIK POPRZECZNY KĄTOWY angular transverse connector	ŁĄCZNIK KĄTOWY 120° angular connector 120°	WŁĄCZNIK BEZDOTYKOWY contactless switch
					
14-5001-00	14-3032-02	14-3030-01	14-3038-01	14-3036-01	14-7052-00

inSILEDA
LUMINES



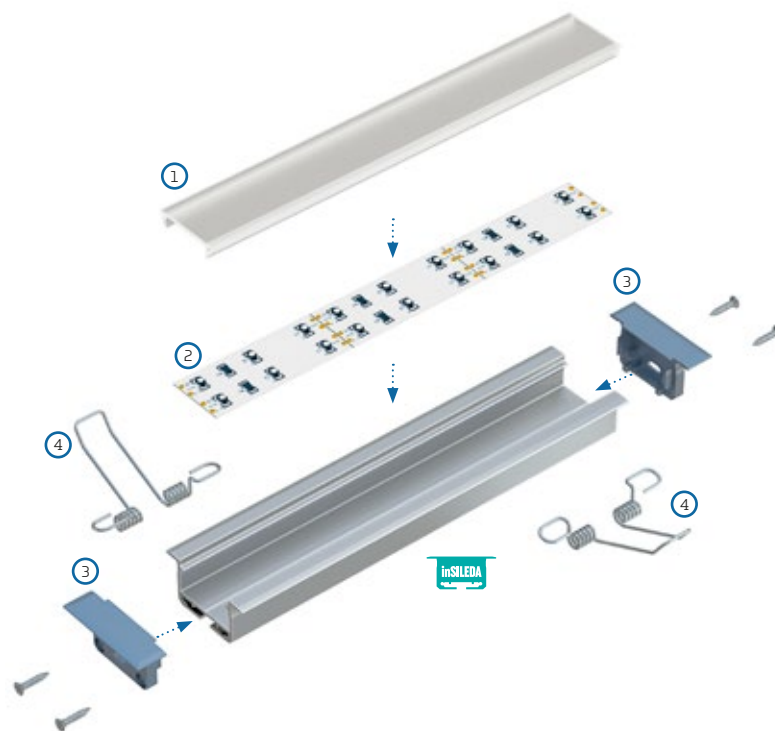

PL

Schemat złożenia elementów systemu oświetleniowego z wykorzystaniem profilu inSILEDA oraz (1) klosza DOUBLE, (2) taśm LED, (3) zaślepek z otworem, oraz (4) sprężyn montażowych.

EN

Assembly scheme for elements of the lighting system using profile inSILEDA and (1) DOUBLE cover (2), LED strips, (3) end caps with hole and (4) mounting springs.



DILEDA

Profil LED / Profile LED

PL
Profil nawierzchniowy – do budowy oświetlenia z użyciem dwóch taśm.

EN
Surface profile for line lighting with two LED strips.

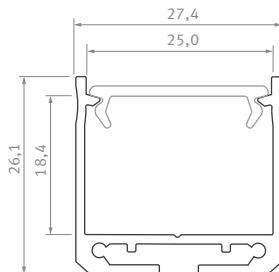

Sposoby montażu /
Assembly methods



DILEDA



Profil LED / Profile LED

Wymiary [mm] / Dimensions (mm): 1000, 2020, 3000

	BIAŁY (lakierowany) white (lacquered)	CZARNY (lakierowany) black (lacquered)	SREBRNY (anodowany) silver (anodized)
Kolory profili Profile colors			
1,0 m	10-0181-10	10-0185-10	10-0184-10
2,02 m	10-0181-20	10-0185-20	10-0184-20
3,0 m	10-0181-30	10-0185-30	10-0184-30
Szerokość taśmy LED [mm] LED strip width (mm)	2 * 12		

Klosze (PMMA) / Covers

Wymiary [mm] / Dimensions (mm): 1000, 2020, 3000

TRANSPARENTNY transparent	MROŻONY frozen	MLECZNY milky	FROSTED MLECZNY milky frosted	CZARNY PMMA black PMMA	SREBRNY silver
DOUBLE					RASTER DOUBLE
1 m/PMMA 11-2073-10	1 m/PMMA 11-2072-10	1 m/PMMA 11-2071-10	1 m/PMMA 11-2076-10	1 m/PMMA 11-2447-10	1m/ 14-0000-48

Zaślepki (aluminium i tworzywo sztuczne) / End caps (aluminum and plastic)

Z OTWOREM with a hole			BEZ OTWORU without a hole		
BIAŁY white	CZARNY black	SREBRNY silver	BIAŁY white	CZARNY black	SREBRNY silver
ALU 12-0191-10	ALU 12-0192-10	ALU 12-0195-10	ALU 12-0191-11	ALU 12-0192-11	ALU 12-0195-11
Z OTWOREM TRASOWANYM with push-hole					
BIAŁY white	CZARNY black	SREBRNY / SZARY silver / gray			
ABS 12-0931-01	ABS 12-0932-01	ABS 12-0934-01	ABS lacq. 12-0935-01		

Dodatki / Accessories

UCHWYT DILEDA METALOWY metal mounting clip DILEDA	WŁĄCZNIK BEZDOTYKOWY contactless switch	PODSTAWKA hinge joint base	PRZEGUB ŻEŃSKI female hinge joint	PRZEGUB MĘSKI male hinge joint	ZAWIAS hinge
13-0000-02	14-7052-00	14-6044-02	14-6044-04	14-6044-03	14-6045-00
ŁĄCZNIK PROSTY straight connector	ŁĄCZNIK KĄTOWY 90° angular connector 90°	ŁĄCZNIK POPRZECZNY KĄTOWY angular transverse connector	ŁĄCZNIK KĄTOWY 120° angular connector 120°	UCHWYT NA PRZEWÓD fi 5 mm cable fi 5 mm holder	ZAWIESIA pendants
14-3032-02	14-3030-01	14-3038-01	14-3036-01	*T 14-7067-00 *B 14-7067-02	*S 14-2011-02 *B 14-2076-00
				*W 14-2075-00	*W 14-2075-00

* S SREBRNY silver; * B CZARNY black; * T TRANSPARENTNY transparent; * W BIAŁY white

LUMINES[®]
LIGHTING

DILEDA
LUMINES



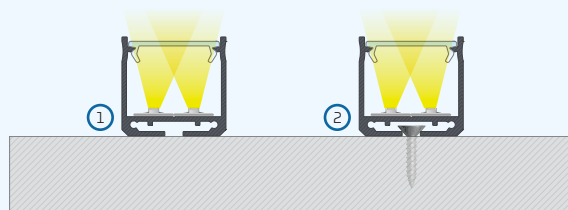
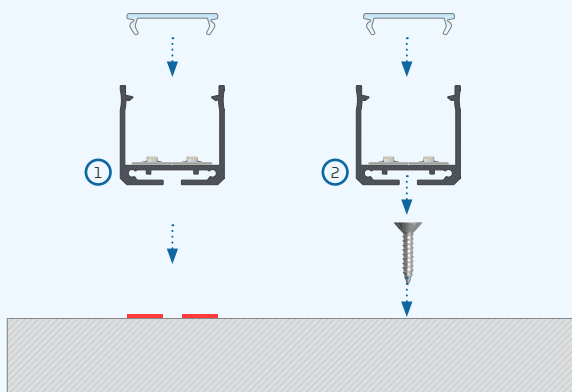

PL
Instrukcja montażu profilu DILEDA z kloszem DOUBLE z wykorzystaniem (1) taśmy dwustronnej, (2) wkrętu montażowego.

EN
Instruction of the assembly of DILEDA profile with DOUBLE cover using (1) double-sided tape, (2) mounting screw.

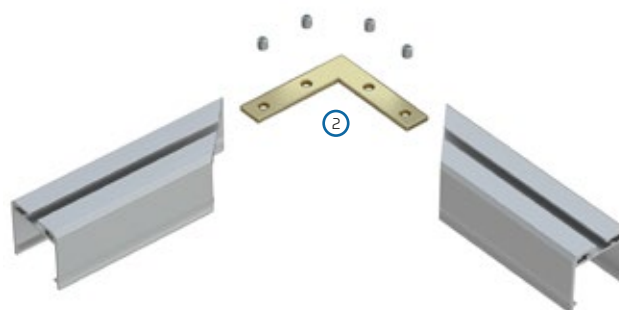
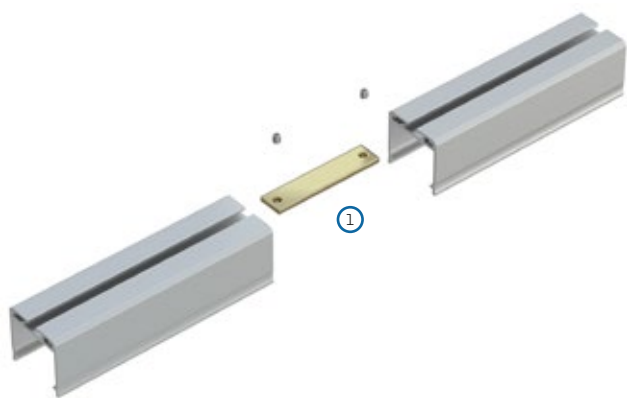

PL
Łączenie profili DILEDA za pomocą (1) łącznika prostego i (2) łącznika kątowego.

EN
Connecting profiles DILEDA using (1) straight connector and (2) angular connector.

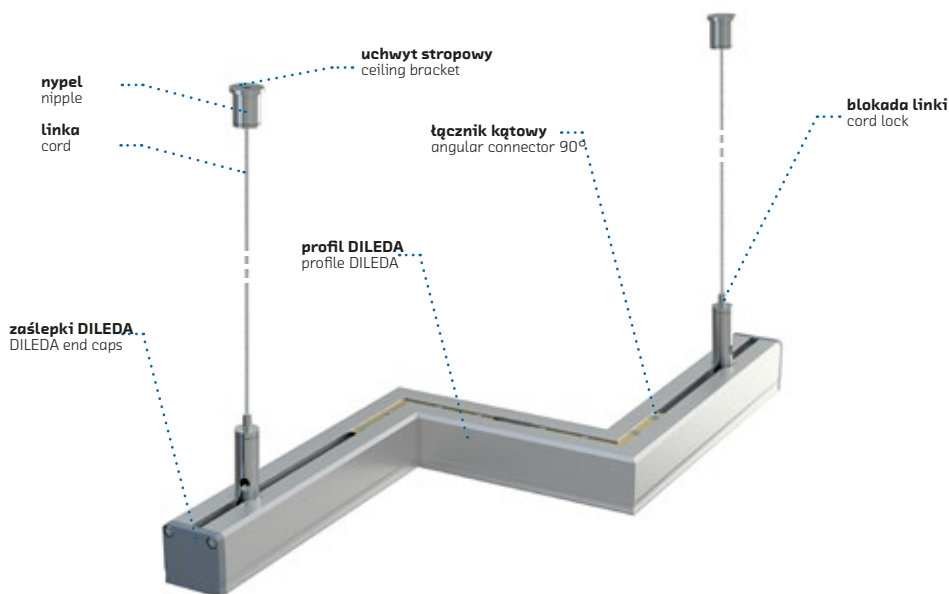

PL
Montaż profilu DILEDA jako element lampy wiszącej.

EN
Assembly of DILEDA profile as a pendant lamp.

inDILEDA

Profil LED / Profile LED

PL

Profil wpuszczany architektoniczny, do montażu oświetlenia z użyciem dwóch taśm. Do zastosowań w biurach i budynkach przemysłowych.

EN

Recessed architectural profile – for line lighting with two LED strips. To be used in office spaces and industrial facilities.

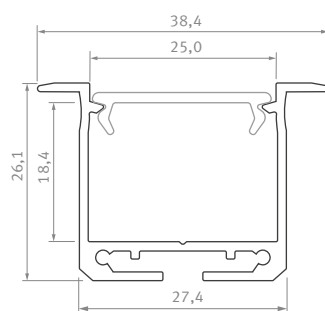

Sposoby montażu /
Assembly methods

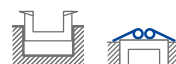



inDILEDA







Profil LED / Profile LED

Wymiary [mm] / Dimensions (mm): 1000, 2020, 3000

	BIAŁY (lakierowany) white (lacquered)	CZARNY (lakierowany) black (lacquered)	SREBRNY (anodowany) silver (anodized)
Kolory profili Profile colors			
1,0 m	10-0201-10	10-0205-10	10-0204-10
2,02 m	10-0201-20	10-0205-20	10-0204-20
3,0 m	10-0201-30	10-0205-30	10-0204-30
Szerokość taśmy LED [mm] LED strip width (mm)	2 * 12		

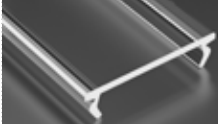
Klosze (PMMA) / Covers

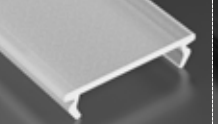

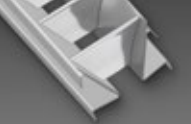



Wymiary [mm] / Dimensions (mm): 1000, 2020, 3000

TRANSPARENTNY transparent	MROŻONY frozen	MLECZNY milky	FROSTED MLECZNY milky frosted	CZARNY PMMA black PMMA	SREBRNY silver
DOUBLE					RASTER DOUBLE
					
1 m/PMMA 11-2073-10	1 m/PMMA 11-2072-10	1 m/PMMA 11-2071-10	1 m/PMMA 11-2076-10	1 m/PMMA 11-2447-10	1m/ 14-0000-48

Zasłepki (aluminium i tworzywo sztuczne) / End caps (aluminum and plastic)

Z OTWOREM with a hole		
BIAŁY white	CZARNY black	SREBRNY / SZARY silver / gray
		
ALU 12-0391-10 ABS 12-0961-00	ALU 12-0000-09	ALU 12-0395-10 ABS lacq. 12-0965-00 ABS 12-0964-00

Dodatki / Accessories

SPRĘŻYNY MONTAŻOWE mounting springs	ŁĄCZNIK PROSTY straight connector	ŁĄCZNIK KĄTOWY 90° angular connector 90°	ŁĄCZNIK POPRZECZNY KĄTOWY angular transverse connector	ŁĄCZNIK KĄTOWY 120° angular connector 120°	WŁĄCZNIK BEZDOTYKOWY contactless switch
					
14-5001-00	14-3032-02	14-3030-01	14-3038-01	14-3036-01	14-7052-00

LUMINES[®]
LIGHTING



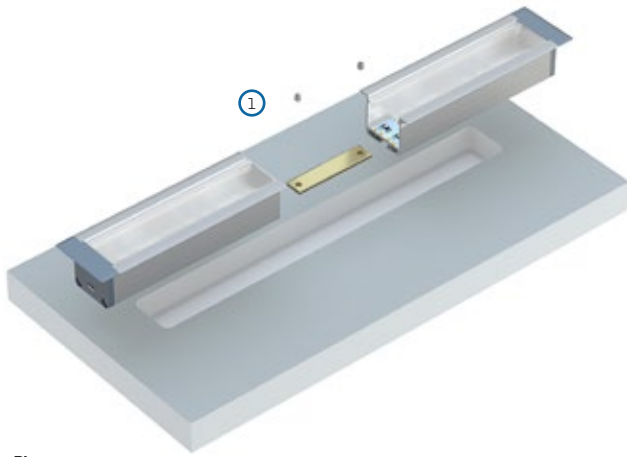

PL
Łączenie profili inDILEDA za pomocą (1) łącznika prostego lub (2) łącznika kątowego w wyfrezowanym otworze.

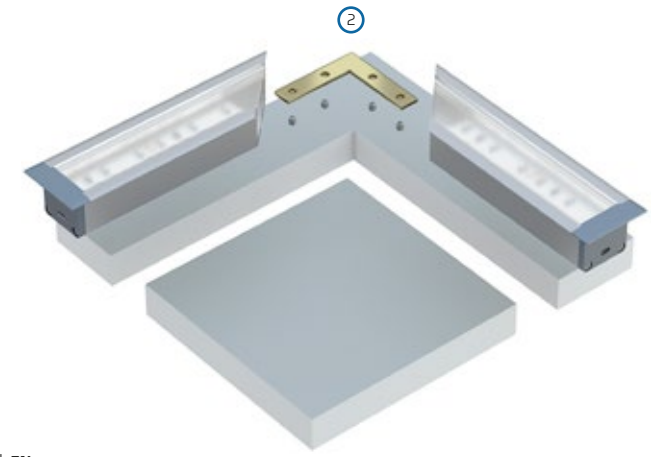

EN
Connecting inDILEDA profiles using (1) straight connector or (2) angular connector in a milled groove.

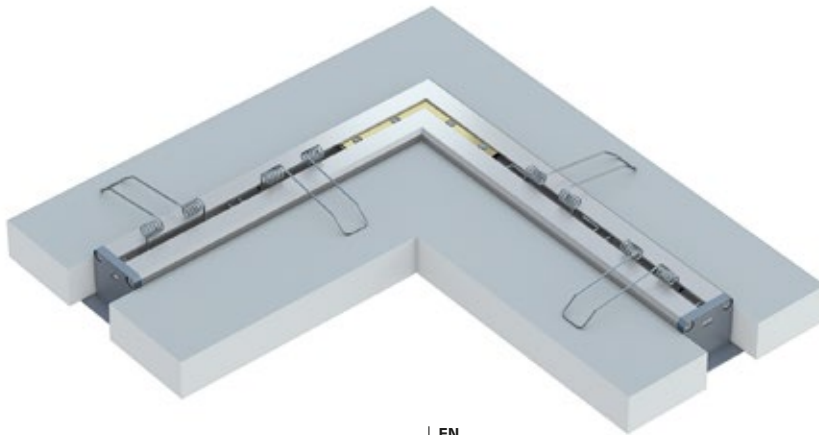

PL
Efekt końcowy montażu profili inDILEDA za pomocą łącznika kątowego z wykorzystaniem sprężyn montażowych.

EN
End result of the assembly of inDILEDA profiles using the angular connector and mounting springs.



UNICO

Profil LED / Profile LED

PL

Profil nawierzchniowy jednostronny – do oświetlenia kierunkowego w pomieszczeniach użyteczności publicznej i biurowych.

EN

One-side surface profile – for the purpose of directional lighting like wallwasher effect inside the public utility premises and office spaces.

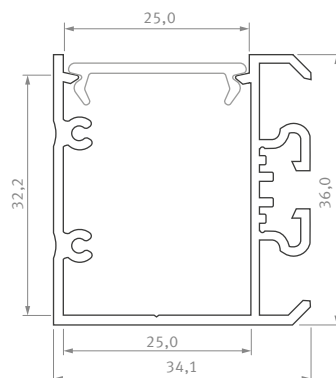

Sposoby montażu /
Assembly methods



UNICO



Profil LED / Profile LED

Wymiary [mm] / Dimensions (mm): 1000, 2020, 3000

	BIAŁY (lakierowany) white (lacquered)	CZARNY (lakierowany) black (lacquered)	SREBRNY (anodowany) silver (anodized)
Kolory profili Profile colors			
1,0 m	10-0391-10	10-0825-10	10-0394-10
2,02 m	10-0391-20	10-1395-20	10-0394-20
3,0 m	10-0391-30	10-0825-30	10-0394-30
Szerokość taśmy LED (mm) LED strip width (mm)	2 x 12		

Klosze (PMMA) / Covers

Wymiary [mm] / Dimensions (mm): 1000, 2020, 3000

TRANSPARENTNY transparent	MROŻONY frozen	MLECZNY milky	FROSTED MLECZNY milky frosted	CZARNY PMMA black PMMA
DOUBLE				
1 m/PMMA 11-2073-10	1 m/PMMA 11-2072-10	1 m/PMMA 11-2071-10	1 m/PMMA 11-2076-10	1 m/PMMA 11-2447-10

Zaślepki (aluminium) / End caps (aluminum)

Z OTWOREM with a hole						BEZ OTWORU without a hole					
BIAŁY white		CZARNY black		SREBRNY silver		BIAŁY white		CZARNY black		SREBRNY silver	
UNICO											
LEWA left	PRAWA right	LEWA left	PRAWA right	LEWA left	PRAWA right	LEWA left	PRAWA right	LEWA left	PRAWA right	LEWA left	PRAWA right
ALU 12-0871-10;ALU 12-0881-10;ALU 12-0000-30;ALU 12-0892-10;ALU 12-0875-10;ALU 12-0885-10;ALU 12-0871-11;ALU 12-0881-11;ALU 12-0000-29;ALU 12-0000-31;ALU 12-0875-11;ALU 12-0885-11											
UNICO + TALIA M2						UNICO + TALIA M2					
LEWA left	PRAWA right	LEWA left	PRAWA right	LEWA left	PRAWA right	LEWA left	PRAWA right	LEWA left	PRAWA right	LEWA left	PRAWA right
ALU 12-1121-10;ALU 12-1131-10;ALU 12-0742-10;ALU 12-0752-10;ALU 12-1125-10;ALU 12-1135-10;ALU 12-1121-11;ALU 12-1131-11;ALU 12-0000-27;ALU 12-0000-28;ALU 12-1125-11;ALU 12-1135-11											

Dodatki / Accessories

ŁĄCZNIK PROSTY straight connector	ŁĄCZNIK KĄTOWY 90° angular connector 90°	ŁĄCZNIK POPRZECZNY KĄTOWY angular transverse connector	ŁĄCZNIK KĄTOWY 120° angular connector 120°	
14-3032-02	14-3030-01	14-3038-01	14-3036-01	
PROFIL MONTAŻOWY TALIA M1 mounting profile TALIA M1	PROFIL MONTAŻOWY TALIA M2 mounting profile TALIA M2	DŁAWNICA cable gland	UCHWYT NA PRZEWÓD fi 5 mm cable fi 5 mm holder	ZAWIESIA pendants
10-0344-10	10-0354-10	*B 14-5046-00 *W 14-5046-01	*T 14-7067-00 *B 14-7067-02	*S 14-2011-02 *B 14-2076-00 *W 14-2075-00

* S SREBRNY silver; * B CZARNY black; * T TRANSPARENTNY transparent; * W BIAŁY white



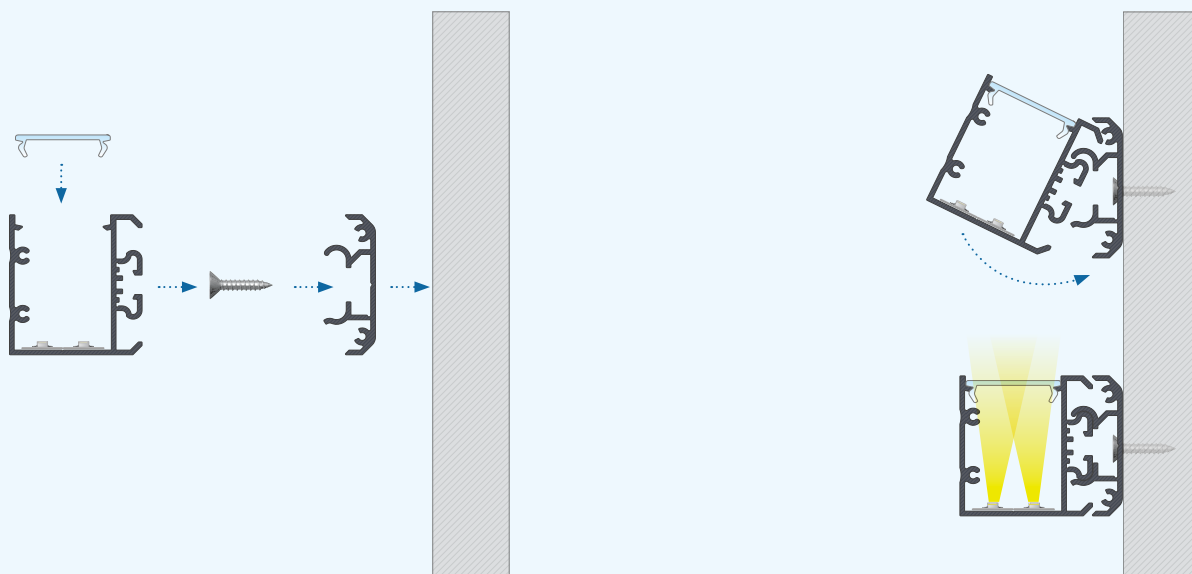

PL

Instrukcja montażu profilu UNICO z kloszem DOUBLE z wykorzystaniem wkrętu montażowego oraz profilu montażowego TALIA M1.

EN

Instruction of the assembly of UNICO profile with DOUBLE cover using the mounting screw and TALIA M1 mounting profile.

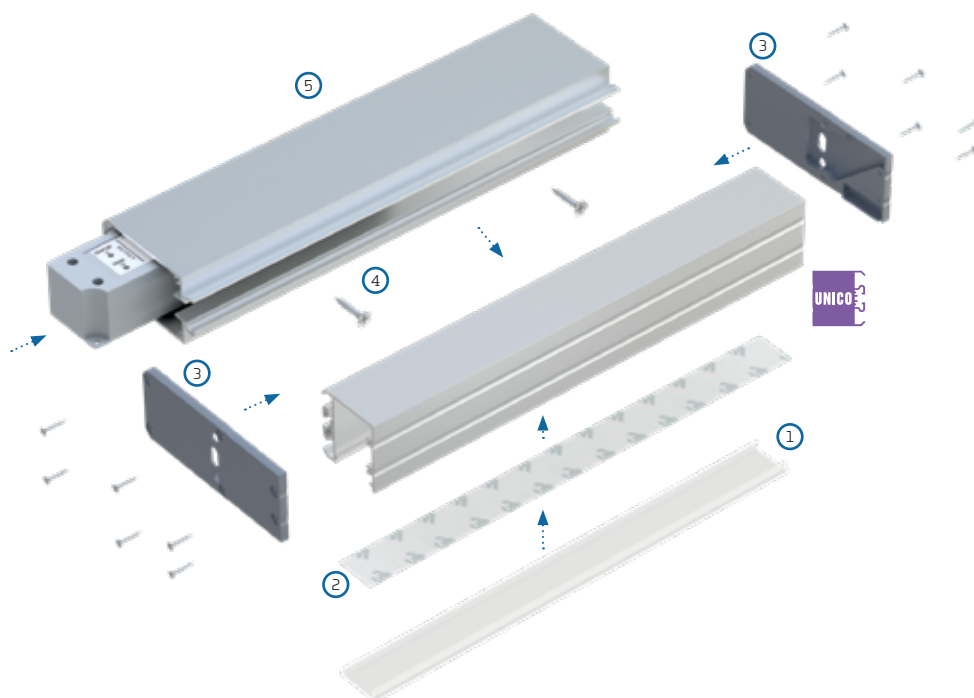

PL

Schemat złożenia elementów systemu oświetleniowego z wykorzystaniem profilu UNICO oraz (1) klosza DOUBLE, (2) taśm LED, (3) zaśleпки z otworem, (4) wkrętu montażowego oraz (5) profilu montażowego TALIA M2.

EN

Assembly scheme for elements of the lighting system using profile UNICO and (1) DOUBLE cover, (2) LED strips, (3) end cap with hole, (4) mounting screw, (5) mounting profile TALIA M2.

DOPIO

Profil LED / Profile LED

PL
Profil nawierzchniowy dwustronny – do oświetlenia powierzchni biurowych, powierzchni typu open space i budownictwie przemysłowym.

EN
Two-side surface mounted profile – for the purpose of lighting office spaces, open space areas and in the field of engineering construction sector.

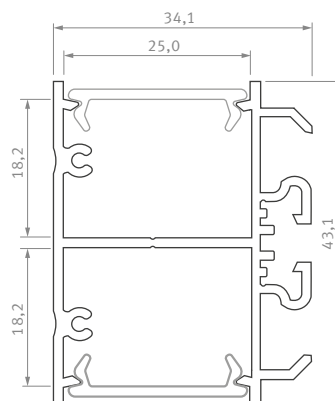

Sposoby montażu /
Assembly methods





DOPIO



Profil LED / Profile LED

Wymiary [mm] / Dimensions [mm]: 1000, 2020, 3000

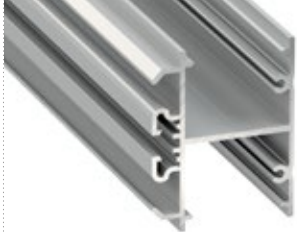

	BIAŁY (lakierowany) white (lacquered)	CZARNY (lakierowany) black (lacquered)	SREBRNY (anodowany) silver (anodized)
Kolory profili Profile colors			
1,0 m	10-0191-10	10-0000-16	10-0194-10
2,02 m	10-0191-20	10-0195-20	10-0194-20
3,0 m	10-0191-30	10-0000-17	10-0194-30
Szerokość taśmy LED [mm] LED strip width [mm]	4 × 12		

Klosze (PMMA) / Covers







Wymiary [mm] / Dimensions [mm]: 1000, 2020, 3000

TRANSPARENTNY transparent	MROŻONY frozen	MLECZNY milky	FROSTED MLECZNY milky frosted	CZARNY PMMA black PMMA
DOUBLE				
				
1 m/PMMA 11-2073-10	1 m/PMMA 11-2072-10	1 m/PMMA 11-2071-10	1 m/PMMA 11-2076-10	1 m/PMMA 11-2447-10

Zaślepki (aluminium) / End caps (aluminum)

Z OTWOREM with a hole			BEZ OTWORU without a hole		
BIAŁY white	CZARNY black	SREBRNY silver	BIAŁY white	CZARNY black	SREBRNY silver
DOPIO					
					
ALU 12-0201-10	ALU 12-0000-04	ALU 12-0205-10	ALU 12-0201-11	ALU 12-0000-55	ALU 12-0205-11
DOPIO + TALIA M2			DOPIO + TALIA M2		
					
ALU 12-1111-10	ALU 12-0000-26	ALU 12-1115-10	ALU 12-1111-11	ALU 12-0000-25	ALU 12-1115-11

Dodatki / Accessories

ŁĄCZNIK PROSTY straight connector	PROFIL MONTAŻOWY TALIA M1 mounting profile TALIA M1	PROFIL MONTAŻOWY TALIA M2 mounting profile TALIA M2	DŁAWNICA cable gland	UCHWYT NA PRZEWÓD fi 5 mm cable fi 5 mm holder	ZAWIESIA pendants
					
14-3032-02	10-0344-10	10-0354-10	*B 14-5046-00 *W 14-5046-01	*T 14-7067-00 *B 14-7067-02	*S 14-2011-02 *B 14-2076-00 *W 14-2075-00

* S SREBRNY silver; * B CZARNY black; * T TRANSPARENTNY transparent; * W BIAŁY white

221

DOPIO
LUMINES

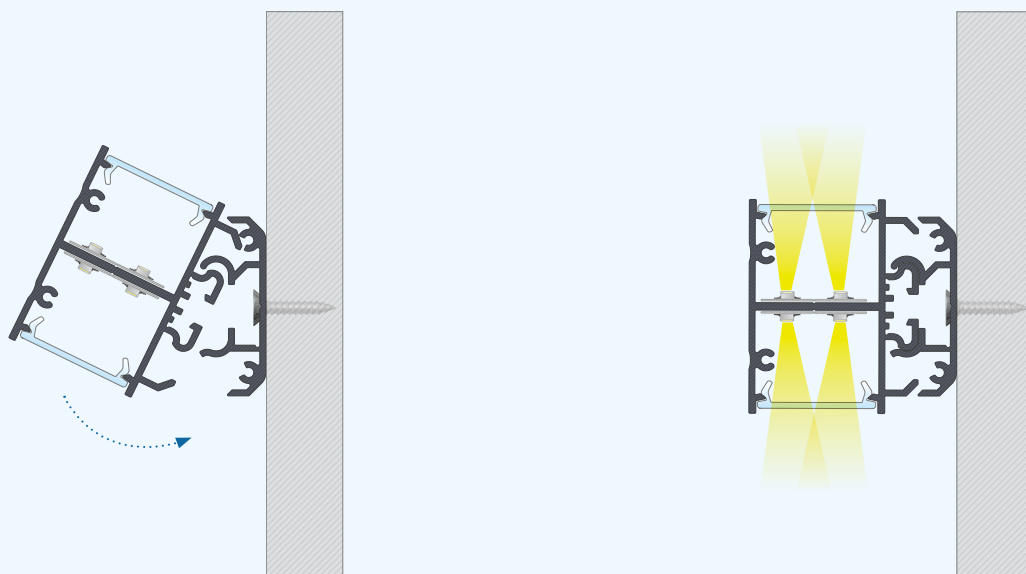

**PL**

Zasada montażu profilu DOPIO z kloszami DOUBLE z wykorzystaniem wkrętu montażowego oraz profilu montażowego TALIA M1.

EN

Instruction of the assembly of DOPIO profile with DOUBLE cover using the mounting screw and TALIA M1 mounting profile.



SOLIS

Profil LED / Profile LED

PL

Profil nawierzchniowy – do oświetlenia pomieszczeń domowych, biurowych – oświetlenie wiszące.

EN

Surface-mounted profile – for household and office room illumination – hanging lighting.

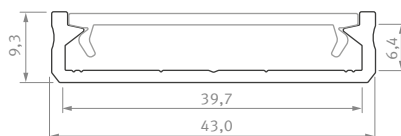

SOLIS

Sposoby montażu /
Assembly methods

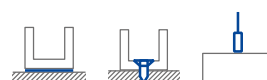





SOLIS

SOLIS



Profil LED / Profile LED

Wymiary [mm] / Dimensions [mm]: 1000, 2020, 3000





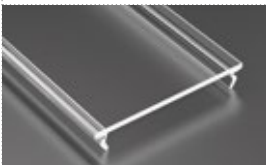
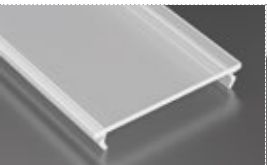

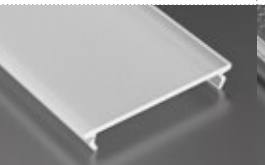
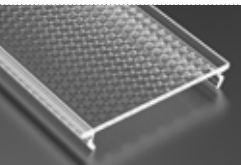



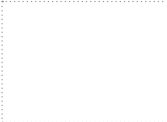

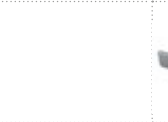



	BIAŁY (lakierowany) white (lacquered)	CZARNY (anodowany) black (anodized)	INOX (anodowany) inox (anodized)	SREBRNY (anodowany) silver (anodized)	SUROWY raw
Kolory profili Profile colors					
1,0 m	10-0141-10	10-0142-10	10-0143-10	10-0144-10	10-0140-10
2,02 m	10-0141-20	10-0142-20	10-0143-10	10-0144-20	10-0140-20
3,0 m	10-0141-30	10-0142-30	10-0143-10	10-0144-30	10-0140-30
Szerokość taśmy LED [mm] LED strip width [mm]	3 * 10				

Klosze (PVC/PMMA/PC) / Covers

Wymiary [mm] / Dimensions [mm]: 1000, 2020, 3000

TRANSPARENTNY transparent	MROŻONY frozen	MLECZNY milky	FROSTED MLECZNY milky frosted	TRANSPARENTNY transparent
WIDE				PRISMATIC PC
				
1 m/PMMA 11-2033-10 1 m/PC 11-3033-10	1 m/PMMA 11-2032-10 1 m/PC 11-3032-10	1 m/PMMA 11-2031-10 1 m/PC 11-3031-10	1 m/PMMA 11-2036-10	1 m/PC 11-3034-10

Zaślepki (aluminium i tworzywo sztuczne) / End caps (aluminum and plastic)

Z OTWOREM with a hole				BEZ OTWORU without a hole			
BIAŁY white	CZARNY black	INOX inox	SREBRNY / SZARY silver / gray	BIAŁY white	CZARNY black	INOX inox	SREBRNY / SZARY silver / gray
							
	ALU 12-0132-10		ALU 12-0135-10 ABS lacq.12-0135-00		ALU 12-0132-11		ALU 12-0135-11 ABS lacq.12-0135-01
Z OTWOREM TRASOWANYM with push-hole							
							
ABS 12-1161-01	ABS 12-1172-01	ABS 12-1183-01	ABS 12-1195-01 ABS lacq.12-1104-01				

Dodatki / Accessories

UCHWYT SOLIS METALOWY metal mounting clip SOLIS	UCHWYT NA PRZEWÓD \varnothing 5 mm cable \varnothing 5 mm holder	ZAWIESIA pendants
		
13-0010-02	*T 14-7067-00 *B 14-7067-02	*S 14-2011-02 *B 14-2076-00 *W 14-2075-00

* S SREBRNY silver; * B CZARNY black; * T TRANSPARENTNY transparent; * W BIAŁY white

SOLIS
LUMINES



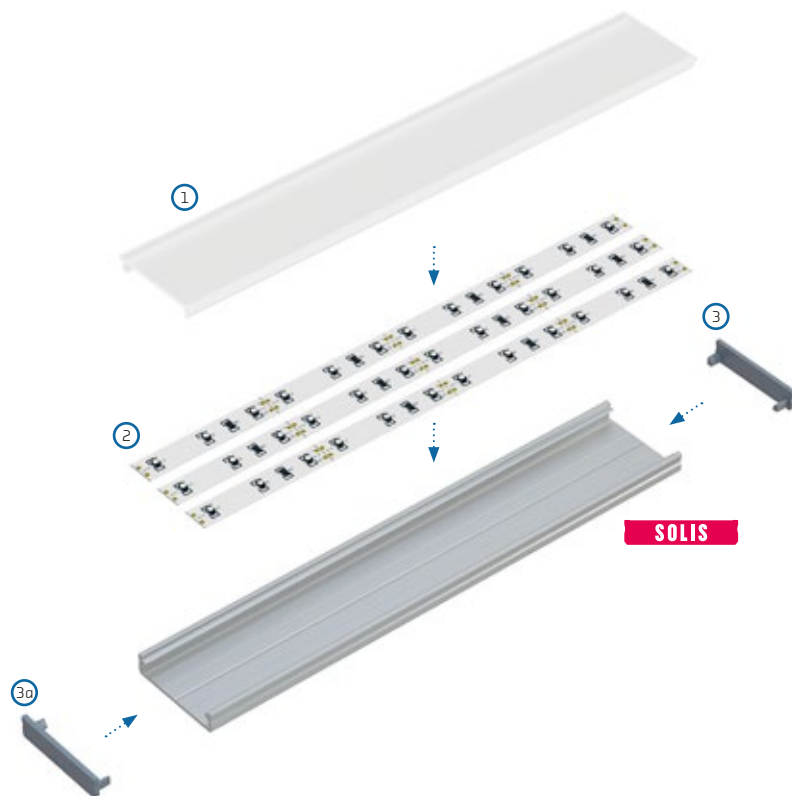

PL

Schemat złożenia elementów systemu oświetleniowego z wykorzystaniem profilu SOLIS oraz (1) klosza WIDE, (2) trzech taśm LED, (3) zaślepki bez otworu, (3a) zaślepki z otworem.

EN

Assembly scheme for elements of the lighting system using profile SOLIS and (1) WIDE cover, (2) three LED strips, (3) end cap without hole, (3a) end cap with hole.

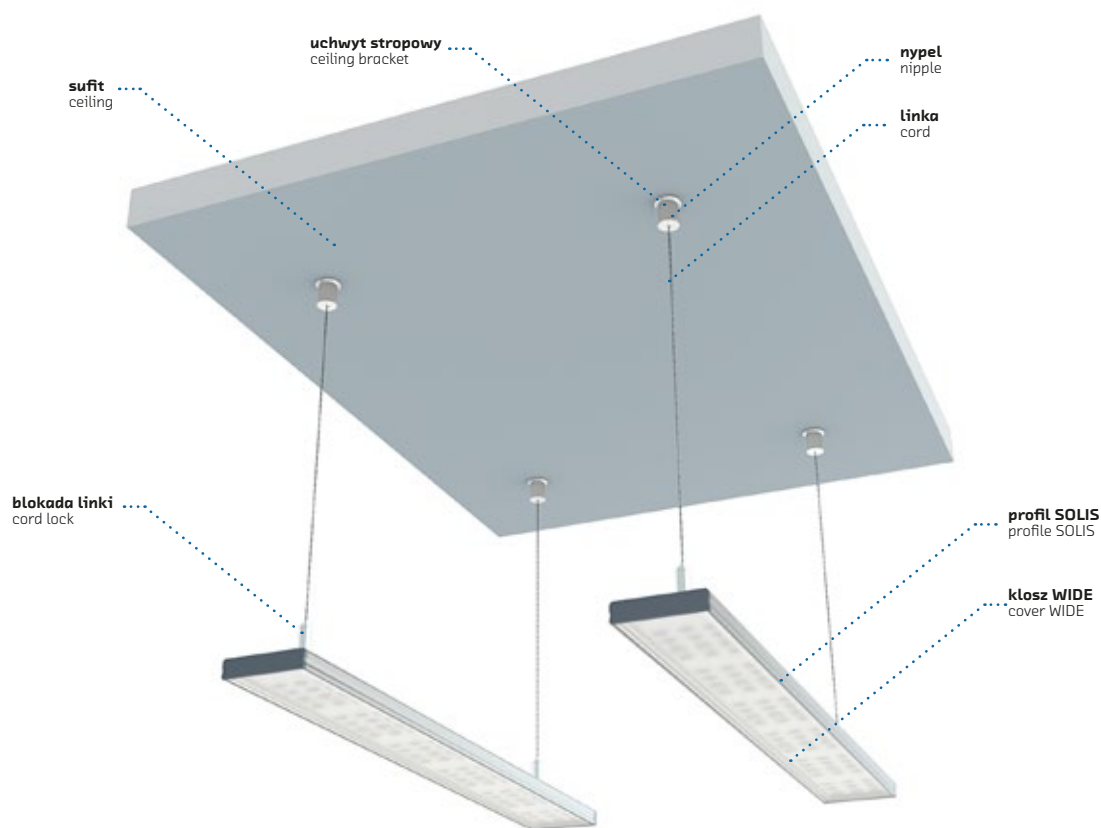

PL

Montaż profilu SOLIS jako lampy wiszącej.

EN

Assembly of SOLIS profile as a pendant lamp.

ILEDO

Profil LED / Profile LED

PL

Do oświetlenia pomieszczeń biurowych, sklepowych oraz domowych – oświetlenie wiszące, architektoniczne.

EN

For lighting in offices, stores and homes – hanging, architectural lighting.

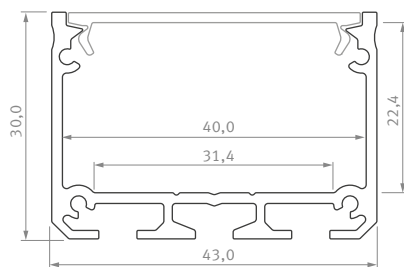

Sposoby montażu /
Assembly methods

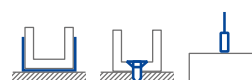

ILEDO



Profil LED / Profile LED

Wymiary [mm] / Dimensions (mm): 1000, 2020, 3000

	BIAŁY (lakierowany) white (lacquered)	CZARNY (lakierowany) black (lacquered)	SREBRNY (anodowany) silver (anodized)
Kolory profili Profile colors			
1,0 m	10-0111-10	10-0115-10	10-0114-10
2,02 m	10-0111-20	10-0115-20	10-0114-20
3,0 m	10-0111-30	10-0115-30	10-0114-30
Szerokość taśmy LED [mm] LED strip width (mm)	3 * 10		

Klosze (PVC/PMMA/PC) / Covers

Wymiary [mm] / Dimensions (mm): 1000, 2020, 3000

TRANSPARENTNY transparent	MROŻONY frozen	MLECZNY milky	FROSTED MLECZNY milky frosted	TRANSPARENTNY transparent	SREBRNY silver
WIDE				PRISMATIC PC	RASTER WIDE
1 m/PMMA 11-2033-10 1 m/PC 11-3033-10	1 m/PMMA 11-2032-10 1 m/PC 11-3032-10	1 m/PMMA 11-2031-10 1 m/PC 11-3031-10	1 m/PMMA 11-2036-10	1 m/PC 11-3034-10	1m/ 14-7068-00

Zaślepki (aluminium i tworzywo sztuczne) / End caps (aluminum and plastic)

Z OTWOREM with a hole			BEZ OTWORU without a hole		
BIAŁY white	CZARNY black	SREBRNY / SZARY silver / gray	BIAŁY white	CZARNY black	SREBRNY / SZARY silver / gray
ALU 12-0111-10	ALU 12-0112-10	ALU 12-0115-10	ALU 12-0111-11	ALU 12-0112-11	ALU 12-0115-11
Z OTWOREM TRASOWANYM with push-hole					
ABS 12-1121-01	ABS 12-1132-01	ABS 12-1154-01 ABS lacq. 12-1145-01			

Dodatki / Accessories

ŁĄCZNIK PROSTY straight connector	ŁĄCZNIK KĄTOWY 90° angular connector 90°	ŁĄCZNIK POPRZECZNY KĄTOWY angular transverse connector	ŁĄCZNIK KĄTOWY 120° angular connector 120°	SPRĘŻYNY MONTAŻOWE mounting springs	
14-3032-02	14-3030-01	14-3038-01	14-3036-01	14-5001-00	
PROFIL MONTAŻOWY MODI mounting profile MODI			UCHWYT A METALOWY metal mounting clip	UCHWYT NA PRZEWÓD fi 5 mm cable fi 5 mm holder	ZAWIESIA pendants
*S 1 m/10-0134-10	*W 10-0131-10	*B 10-0135-10	13-0210-02	*T 14-7067-00 *B 14-7067-02	*S 14-2011-02 *B 14-2076-00 *W 14-2075-00

* S SREBRNY silver; * B CZARNY black; * T TRANSPARENTNY transparent; * W BIAŁY white

ILEDO
LUMINES



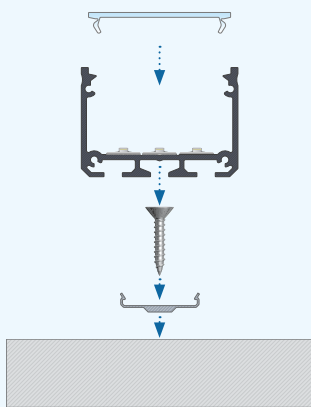

PL
Instrukcja montażu profilu ILEDO z kloszem WIDE za pomocą uchwyty montażowego metalowego.

EN
Installation manual for ILEDO profile with WIDE cover, using metal mounting clip.

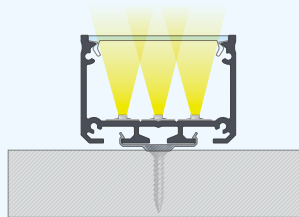

PL
Łączenie profili ILEDO w płaszczyźnie pionowej pod kątem 90°.

EN
Vertical connection of ILEDO profiles at 90 degrees angle.



PL
Łączenie profili ILEDO w płaszczyźnie poziomej pod kątem 90°.

EN
Horizontal connection of ILEDO profiles at 90 degrees angle.



PL
Możliwość ukrycia zasilacza w profilu ILEDO przy wykorzystaniu profilu montażowego MODI.

EN
Possibility to hide the power supply inside of ILEDO profile using MODI mounting profile.

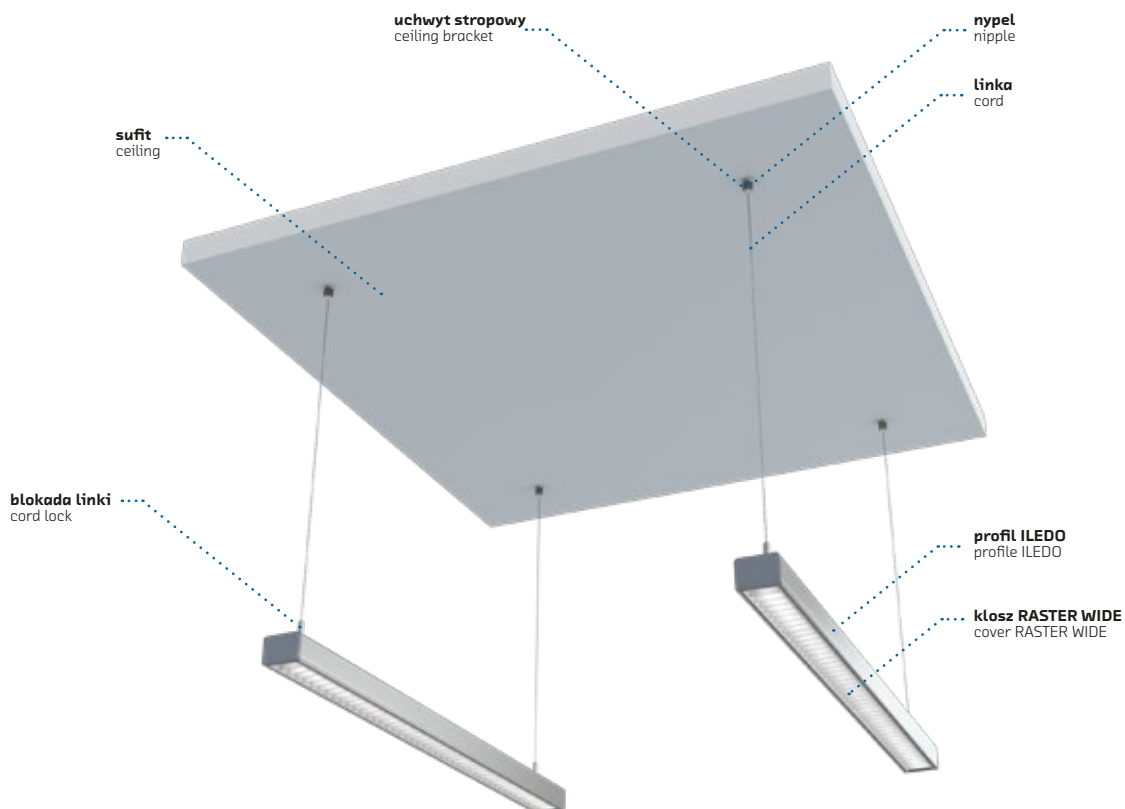

PL
Montaż profilu ILEDO jako lampy wiszącej.

EN
Assembly of ILEDO profile as a pendant lamp.

INSO

Profil LED / Profile LED

PL
Profil wpuszczany – do oświetlenia pomieszczeń biurowych, sklepowych, domowych – oświetlenie architektoniczne – sufitowe, ściennie.

EN
Groove mounted profile – for lighting in offices, stores and homes – architectural lighting – ceiling- and wall-mounted.

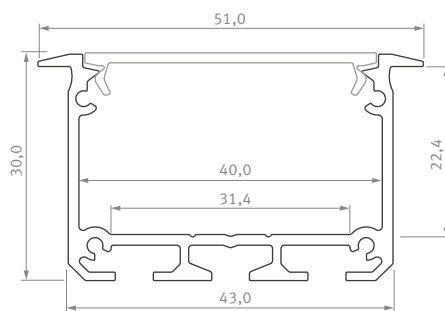

Sposoby montażu /
Assembly methods





INSO

INSO





Profil LED / Profile LED

Wymiary [mm] / Dimensions (mm): 1000, 2020, 3000

Kolory profili Profile colors	BIAŁY (lakierowany) white (lacquered)	CZARNY (lakierowany) black (lacquered)	SREBRNY (anodowany) silver (anodized)
			
1,0 m	10-0121-10	10-0125-10	10-0124-10
2,02 m	10-0121-20	10-0125-20	10-0124-20
3,0 m	10-0121-30	10-0125-30	10-0124-30
Szerokość taśmy LED [mm] LED strip width (mm)	3 * 10		

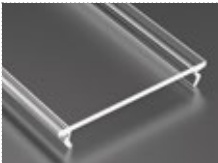
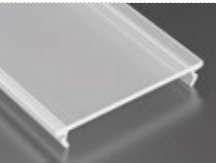
Klosze (PVC/PMMA/PC) / Covers

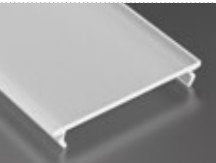
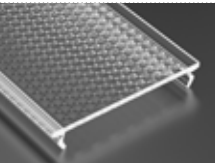
Wymiary [mm] / Dimensions (mm): 1000, 2020, 3000

TRANSPARENTNY transparent	MROŻONY frozen	MLECZNY milky	FROSTED MLECZNY milky frosted	TRANSPARENTNY transparent	SREBRNY silver
WIDE				PRISMATIC PC	RASTER WIDE
					
1 m/PMMA 11-2033-10 1 m/PC 11-3033-10	1 m/PMMA 11-2032-10 1 m/PC 11-3032-10	1 m/PMMA 11-2031-10 1 m/PC 11-3031-10	1 m/PMMA 11-2036-10	1 m/PC 11-3034-10	1m/ 14-7068-00

Zaślepki (aluminium i tworzywo sztuczne) / End caps (aluminum and plastic)

Z OTWOREM with a hole			BEZ OTWORU without a hole		
BIAŁY white	CZARNY black	SREBRNY / SZARY silver / gray	BIAŁY white	CZARNY black	SREBRNY silver
					
ALU 12-0000-12	ALU 12-0000-78	ALU 12-0000-13	ALU 12-0121-11	ALU 12-0122-11	ALU 12-0125-11
					
			ABS 12-0121-01		ABS łącz. 12-0125-01 ABS 12-0124-01

Dodatki / Accessories

ŁĄCZNIK PROSTY straight connector	ŁĄCZNIK KĄTOWY 90° angular connector 90°	ŁĄCZNIK POPRZECZNY KĄTOWY angular transverse connector	ŁĄCZNIK KĄTOWY 120° angular connector 120°
			
14-3032-02	14-3030-01	14-3038-01	14-3036-01
PROFIL MONTAŻOWY MODI mounting profile MODI			SPRĘŻYNY MONTAŻOWE mounting springs
			
*S 1 m/10-0134-10	*W 10-0131-10	*B 10-0135-10	14-5001-00

* S SREBRNY silver; * B CZARNY black; * W BIAŁY white

INSO
LUMINES



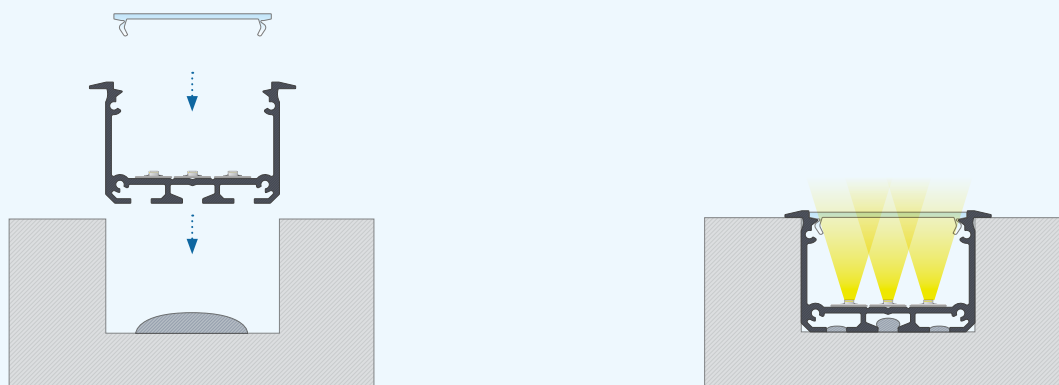

PL
Instrukcja montażu profilu INSO wpuszczanego z kloszem WIDE w wyfrezowanym otworze z dodatkiem kleju montażowego.

EN
Instruction of assembly of recessed INSO profile with WIDE cover in a milled groove with mounting glue.

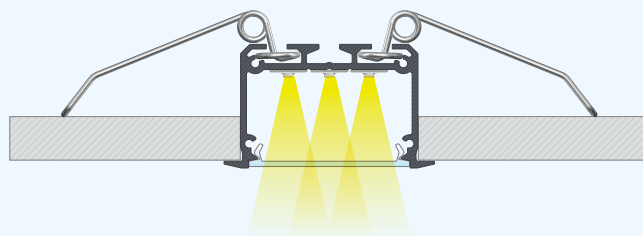

PL
Efekt końcowy montażu profilu INSO z kloszem WIDE wpuszczonego pomiędzy płytami przy pomocy sprężyn montażowych.

EN
End result of the assembly of INSO profile with WIDE cover, between two plasterboards using mounting springs.



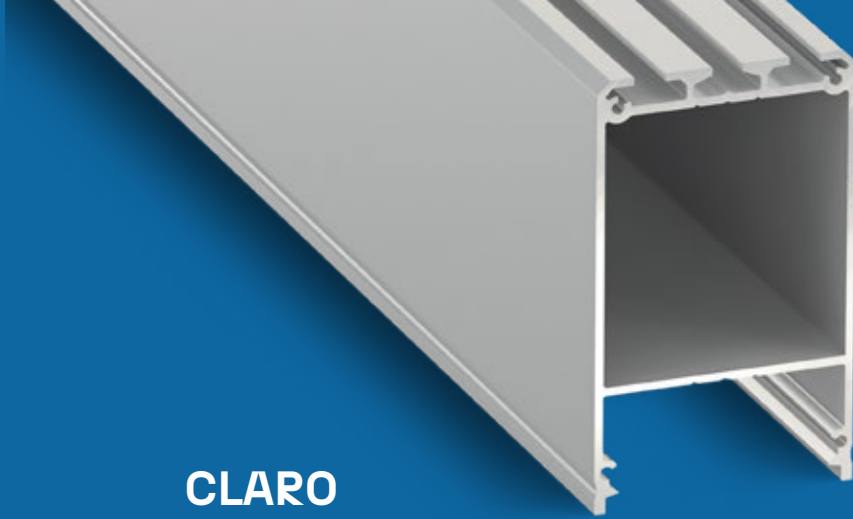

CLARO

Profil LED / Profile LED

PL

Profil nawierzchniowy – do podświetlenia pomieszczeń domowych i przestrzeni biurowych. Do zastosowania w postaci lampy wiszącej, z ukrytym zasilaczem.

EN

Surface-mounted profile – for household and office room illumination – to be used as a pendant lamp with a hidden power supply.

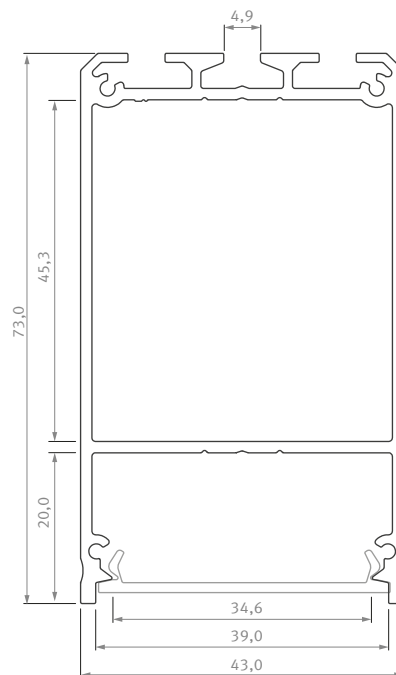

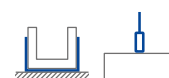

Sposoby montażu /
Assembly methods



CLARO

Profil LED / Profile LED

Wymiary [mm] / Dimensions (mm): 1000, 2020, 3000





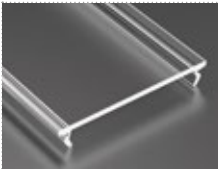
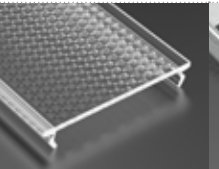

	BIAŁY (lakierowany) white (lacquered)	CZARNY (lakierowany) black (lacquered)	SREBRNY (anodowany) silver (anodized)
Kolory profili Profile colors			
1,0 m	10-0601-10	10-0000-06	10-0604-10
2,02 m	10-0601-20	10-0000-07	10-0604-20
3,0 m	10-0601-30	10-0000-08	10-0604-30
Szerokość taśmy LED (mm) LED strip width (mm)	3 x 12		

Klosze (PVC/PMMA/PC) / Covers







Wymiary [mm] / Dimensions (mm): 1000, 2020, 3000

TRANSPARENTNY transparent	MROŻONY frozen	MLECZNY milky	FROSTED MLECZNY milky frosted	TRANSPARENTNY transparent	SREBRNY silver
WIDE				PRISMATIC PC	RASTER WIDE
					
1 m/PMMA 11-2033-10 1 m/PC 11-3033-10	1 m/PMMA 11-2032-10 1 m/PC 11-3032-10	1 m/PMMA 11-2031-10 1 m/PC 11-3031-10	1 m/PMMA 11-2036-10	1 m/PC 11-3034-10	1m/ 14-7068-00

Zaślepki (aluminium) / End caps (aluminum)

Z OTWOREM with a hole			BEZ OTWORU without a hole		
BIAŁY white	CZARNY black	SREBRNY silver	BIAŁY white	CZARNY black	SREBRNY silver
CLARO					
					
ALU 12-1141-10	ALU 12-0000-54	ALU 12-1145-10	ALU 12-1141-11	ALU 12-0000-53	ALU 12-1145-11

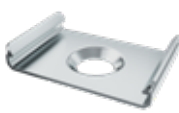
Dodatki / Accessories

ŁĄCZNIK PROSTY straight connector	ŁĄCZNIK KĄTOWY 90° angular connector 90°	ŁĄCZNIK POPRZECZNY KĄTOWY angular transverse connector	ŁĄCZNIK KĄTOWY 120° angular connector 120°	UCHWYT A METALOWY metal mounting clip	UCHWYT NA PRZEWÓD φ 5 mm cable φ 5 mm holder	ZAWIESIA pendants
						
14-3032-02	14-3030-01	14-3038-01	14-3036-01	13-0210-02	*T 14-7067-00 *B 14-7067-02	*S 14-2011-02 *B 14-2076-00 *W 14-2075-00

* S SREBRNY silver; * B CZARNY black; * T TRANSPARENTNY transparent; * W BIAŁY white

CLARO
LUMINES



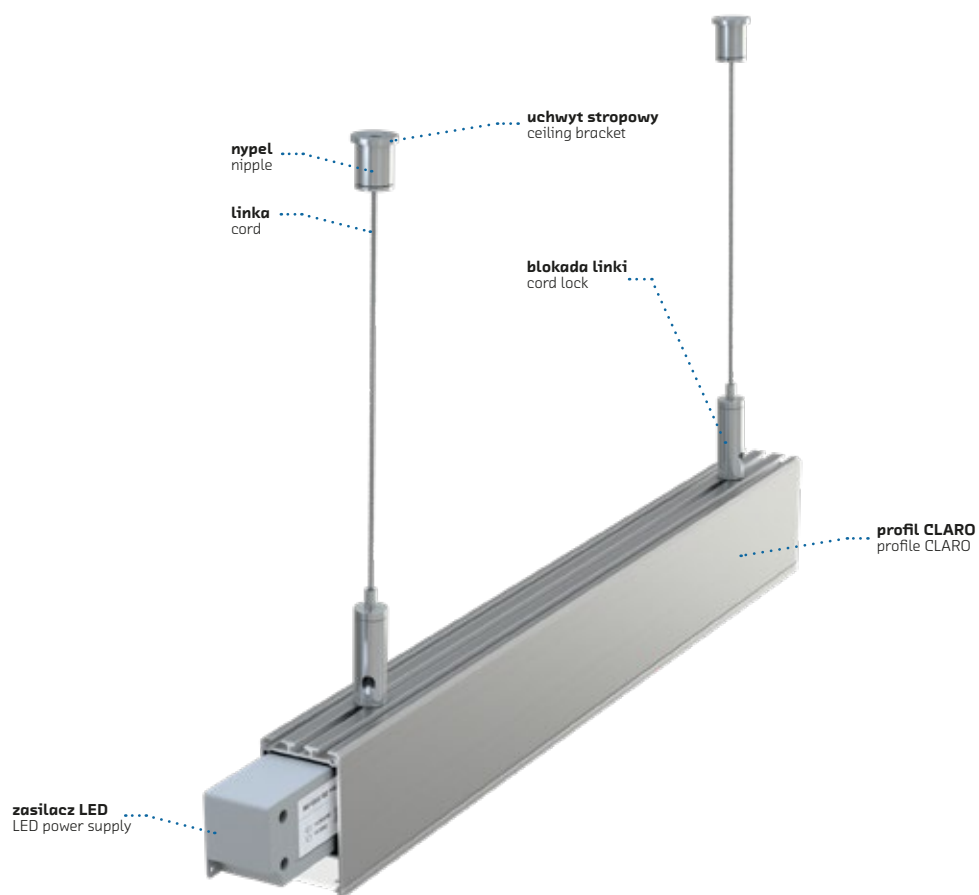

PL
Montaż profilu CLARO jako lampy wiszącej.

EN
Assembly of CLARO profile as a pendant lamp.



DULIO

Profil LED / Profile LED

PL
Profil nawierzchniowy – do podświetlenia pomieszczeń domowych i przestrzeni biurowych. Do zastosowania w postaci lampy wiszącej, z ukrytym zasilaczem.

EN
Surface-mounted profile – for household and office room illumination – to be used as a pendant lamp with a hidden power supply.

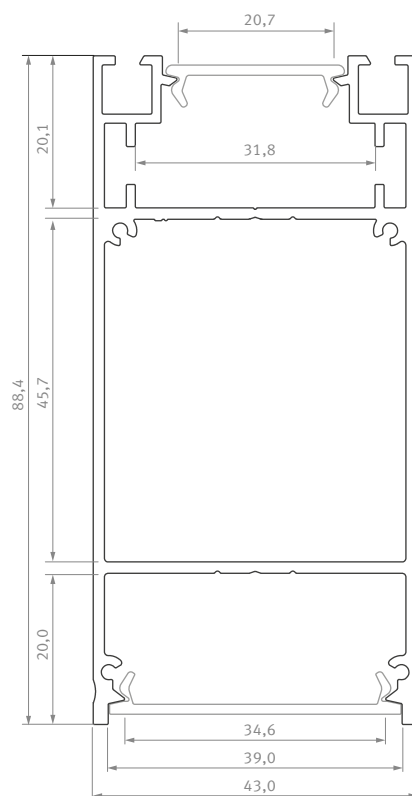



Sposoby montażu /
Assembly methods



DULIO







Profil LED / Profile LED

Wymiary [mm] / Dimensions (mm): 1000, 2020, 3000

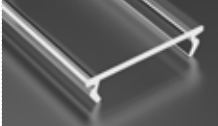
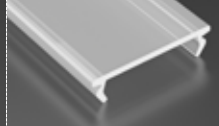

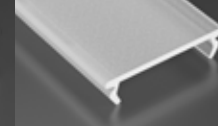

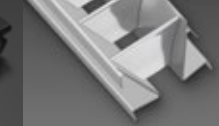
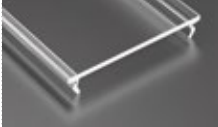
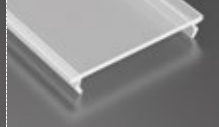
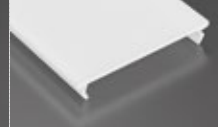

	BIAŁY (lakierowany) white (lacquered)	CZARNY (lakierowany) black (lacquered)	SREBRNY (anodowany) silver (anodized)
Kolory profili Profile colors			
1,0 m	10-0611-10	10-0000-20	10-0614-10
2,02 m	10-0611-20	10-0000-21	10-0614-20
3,0 m	10-0611-30	10-0000-22	10-0614-30
Szerokość taśmy LED (mm) LED strip width (mm)	5 x 12		

Klosze (PVC/PMMA/PC) / Covers

Wymiary [mm] / Dimensions (mm): 1000, 2020, 3000

TRANSPARENTNY transparent	MROŻONY frozen	MLECZNY milky	FROSTED MLECZNY milky frosted	CZARNY PMMA black PMMA	SREBRNY silver
DOUBLE			RASTER DOUBLE		
					
1 m/PMMA 11-2073-10	1 m/PMMA 11-2072-10	1 m/PMMA 11-2071-10	1 m/PMMA 11-2076-10	1 m/PMMA 11-2447-10	1m/ 14-0000-48
TRANSPARENTNY transparent	MROŻONY frozen	MLECZNY milky	FROSTED MLECZNY milky frosted	SREBRNY silver	
WIDE					
					
1 m/PMMA 11-2033-10 1 m/PC 11-3033-10	1 m/PMMA 11-2032-10 1 m/PC 11-3032-10	1 m/PMMA 11-2031-10 1 m/PC 11-3031-10	1 m/PMMA 11-2036-10		

Zaślepki (aluminium) / End caps (aluminum)

Z OTWOREM with a hole			BEZ OTWORU without a hole		
BIAŁY white	CZARNY black	SREBRNY silver	BIAŁY white	CZARNY black	SREBRNY silver
DULIO					
					
ALU 12-1151-10	ALU 12-0000-06	ALU 12-1155-10	ALU 12-1151-11	ALU 12-0000-05	ALU 12-1155-11

Dodatki / Accessories

ŁĄCZNIK PROSTY straight connector	ŁĄCZNIK KĄTOWY 90° angular connector 90°	ŁĄCZNIK POPRZECZNY KĄTOWY angular transverse connector	ŁĄCZNIK KĄTOWY 120° angular connector 120°	UCHWYT NA PRZEWÓD fi 5 mm cable fi 5 mm holder	ZAWIESIA TYPU Y Y-type pendants Y
					
14-3032-02	14-3030-01	14-3038-01	14-3036-01	*T 14-7067-00 *B 14-7067-02	*S 14-2062-00 *B 14-2078-00 *W 14-2077-00

* S SREBRNY silver; * B CZARNY black; * T TRANSPARENTNY transparent; * W BIAŁY white



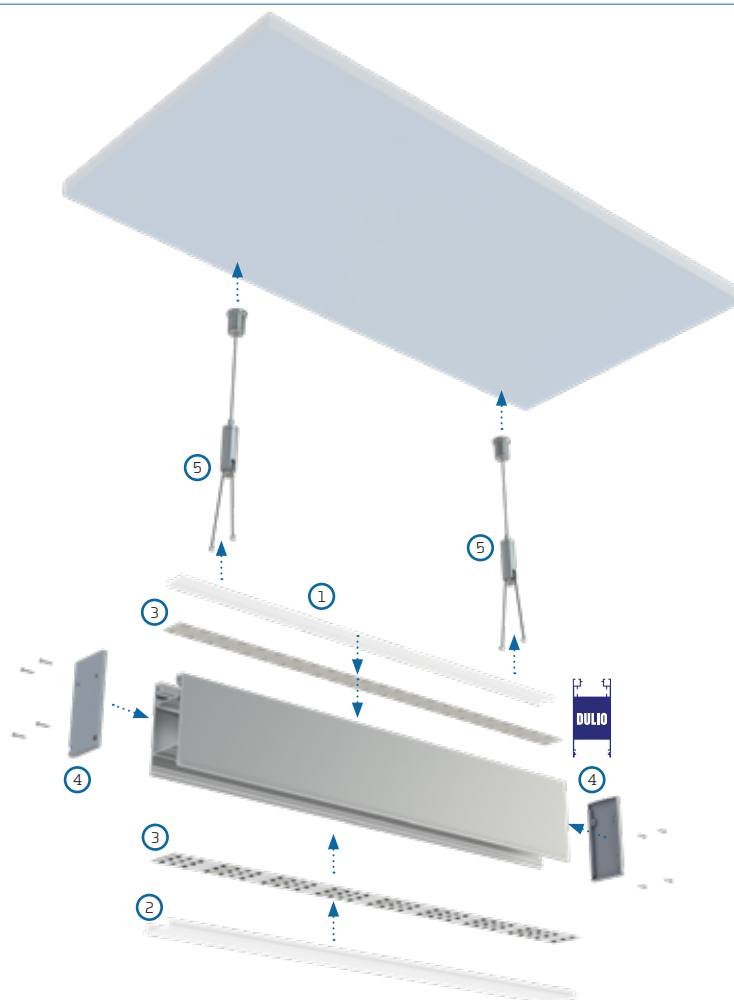

PL
Schemat złożenia elementów systemu oświetleniowego z wykorzystaniem profilu DULIO oraz [1] klosza WIDE, [2] klosza DOUBLE [3] taśm LED, [4] zaślepki końcowej, [5] systemu zawiesi typu Y.

EN
Assembly scheme for elements of the lighting system using profile DULIO and [1] WIDE cover, [2] DOUBLE cover, [3] LED strips, [4] end cap and [5] Y-type pendants.



TALIA

Profil LED / Profile LED

PL
Profil powierzchniowy architektoniczny – do stosowania w budownictwie. Do budowy systemów oświetleniowych z wykorzystaniem dwóch taśm LED.

EN
Surface architectural profile – to be used in construction sector. For the purpose of building the lighting systems using two LED strips.

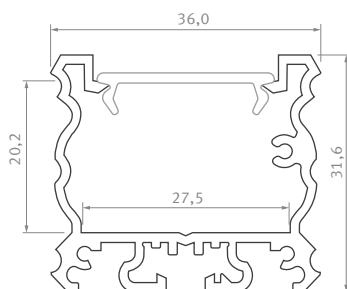

Sposoby montażu /
Assembly methods

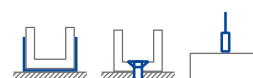

TALIA



Profil LED / Profile LED

Wymiary [mm] / Dimensions (mm): 1000, 2020, 3000

	BIAŁY (lakierowany) white (lacquered)	CZARNY (lakierowany) black (lacquered)	SREBRNY (anodowany) silver (anodized)
Kolory profili Profile colors			
1,0 m	10-0381-10	10-0775-10	10-0384-10
2,02 m	10-0381-20	10-0385-20	10-0384-20
3,0 m	10-0381-30	10-0635-30	10-0384-30
Szerokość taśmy LED (mm) LED strip width (mm)	2 * 12 mm		

Klosze (PMMA) / Covers

Wymiary [mm] / Dimensions (mm): 1000, 2020, 3000

TRANSPARENTNY transparent	MROŻONY frozen	MLECZNY milky	FROSTED MLECZNY milky frosted	CZARNY PMMA black PMMA	SREBRNY silver
DOUBLE					RASTER DOUBLE
1 m/PMMA 11-2073-10	1 m/PMMA 11-2072-10	1 m/PMMA 11-2071-10	1 m/PMMA 11-2076-10	1 m/PMMA 11-2447-10	1m/ 14-0000-48

Zaślepki (aluminium) / End caps (aluminum)

Z OTWOREM with a hole			BEZ OTWORU without a hole		
BIAŁY white	CZARNY black	SREBRNY silver	BIAŁY white	CZARNY black	SREBRNY silver
TALIA					
ALU 12-0671-10	ALU 12-0672-10	ALU 12-0805-10	ALU 12-0671-11	ALU 12-0000-23	ALU 12-0805-11

Dodatki / Accessories

PROFIL MONTAŻOWY TALIA M1 mounting profile TALIA M1 	PROFIL MONTAŻOWY TALIA M2 mounting profile TALIA M2 	PROFIL MONTAŻOWY TALIA M3 mounting profile TALIA M3 	PROFIL MONTAŻOWY TALIA M4 mounting profile TALIA M4 	ŁĄCZNIK PROSTY straight connector 	
10-0344-10	10-0354-10	10-0364-10	10-0374-10	14-3032-02	
ŁĄCZNIK KĄTOWY 90° angular connector 90° 	ŁĄCZNIK POPRZECZNY KĄTOWY angular transverse connector 	ŁĄCZNIK KĄTOWY 120° angular connector 120° 	ŁĄCZNIK MONTAŻOWY TALIA M1 mounting connector TALIA M1 	ŁĄCZNIKI TALIA connector TALIA M1 	
14-3030-01	14-3038-01	14-3036-01	14-3041-02	LEWY left	PRAWY right
DŁAWNICA cable gland 	* B CZARNY black; * W BIAŁY white				
*B 14-5046-00 *W 14-5046-01					

TALIA
LUMINES





TALIA M1

Profil LED / Profile LED

PL

Podstawowy profil montażowy dla profilu TALIA, do montażu nawierzchniowego. Do stosowania przy długich systemach świetlnych z taśmami LED.

EN

Basic assembly profile for TALIA profile, for the purpose of surface mounting. To be using in long lighting systems with LED strips.

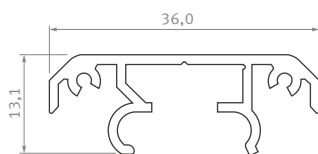

Profil montażowy podstawowy / Mounting profile

Wymiary [mm] / Dimensions (mm): 1000, 2020, 3000

	BIAŁY (lakierowany) white (lacquered)	CZARNY (lakierowany) black (lacquered)	SREBRNY (anodowany) silver (anodized)
Kolory profili Prolife colors			
1,0 m	10-0341-10	10-0345-10	10-0344-10
2,02 m	10-0341-20	10-0345-20	10-0344-20
3,0 m	10-0341-30	10-0785-30	10-0344-30

Zaślepki (aluminium) / End caps (aluminum)

Z OTWOREM with a hole			BEZ OTWORU without a hole		
BIAŁY white	CZARNY black	SREBRNY silver	BIAŁY white	CZARNY black	SREBRNY silver
TALIA M1					
					
ALU 12-0681-10	ALU 12-0702-10	ALU 12-0685-10	ALU 12-0681-11	ALU 12-0000-24	ALU 12-0685-11
TALIA M1 + TALIA					
					
ALU 12-0691-10	ALU 12-0712-10	ALU 12-0695-10	ALU 12-0691-11	ALU 12-0702-11	ALU 12-0695-11

TALIA M2

Profil LED / Profile LED

PL
Profil montażowy zasilaczowy – do estetycznego montażu zasilacza w powierzchniowych systemach oświetleniowych z użyciem profilu TALIA.

EN
Power supply assembly profile – for the aesthetic assembly of the power supply in the surface lighting systems using TALIA profile.

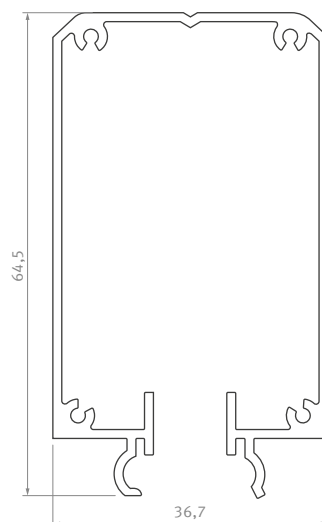

Profil montażowy zasilaczowy / Mounting profile (for power supply)

Wymiary [mm] / Dimensions [mm]: 1000, 2020, 3000

Kolory profili Profile colors	BIAŁY (lakierowany) white (lacquered)	CZARNY (lakierowany) black (lacquered)	SREBRNY (anodowany) silver (anodized)
	1,0 m	10-0351-10	10-0795-10
2,02 m	10-0351-20	10-0355-20	10-0354-20
3,0 m	10-0351-30	10-0795-30	10-0354-30

Zaślepki (aluminium) / End caps (aluminum)

Z OTWOREM with a hole			BEZ OTWORU without a hole		
BIAŁY white	CZARNY black	SREBRNY silver	BIAŁY white	CZARNY black	SREBRNY silver
TALIA M2					
ALU 12-0701-10	ALU 12-0722-10	ALU 12-0705-10	ALU 12-0701-11	ALU 12-0000-73	ALU 12-0705-11
TALIA M2 + TALIA					
ALU 12-0711-10	ALU 12-0732-10	ALU 12-0715-10	ALU 12-0711-11	ALU 12-0722-11	ALU 12-0715-11

TALIA M3

Profil LED / Profile LED

PL

Profil konstrukcyjny dla profilu TALIA, do bezpośredniego montażu w płytach gipsowo kartonowych. Stosowany wraz z łącznikiem międzyprofilowym, umożliwia skierowanie źródła światła w kilku kierunkach.

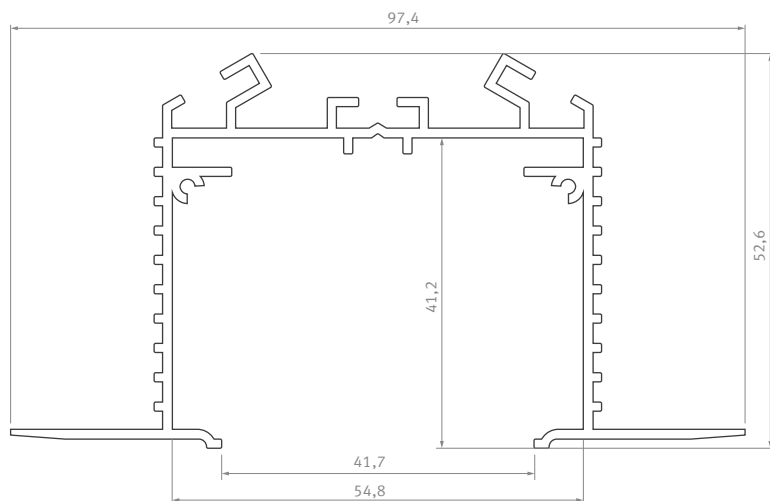

EN

Constructional profile for TALIA – for the direct assembly in drywalls. Used with the interprofile connector; it gives the possibility to focus the light source into the several directions.





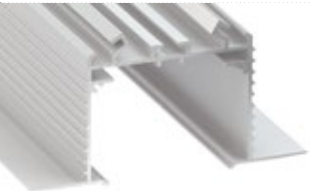
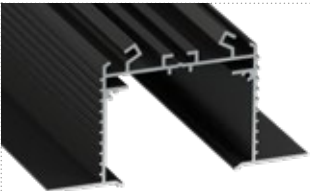



Profil montażowy sufitowy / Mounting profile







Wymiary [mm] / Dimensions [mm]: 1000, 2020, 3000

	BIAŁY (lakierowany) white (lacquered)	CZARNY (lakierowany) black (lacquered)	SREBRNY (anodowany) silver (anodized)
Kolory profili Profile colors			
1,0 m	10-0361-10	10-0535-10	10-0364-10
2,02 m	10-0361-20	10-0535-20	10-0364-20
3,0 m	10-0361-30	10-0535-30	10-0364-30

Zaślepki (aluminium) / End caps (aluminum)

PEŁNE full finish			PROSTE basic finish		
BIAŁY white	CZARNY black	SREBRNY silver	BIAŁY white	CZARNY black	SREBRNY silver
TALIA M3					
					
ALU 12-0721-11	ALU 12-0762-11	ALU 12-0745-11	ALU 12-0731-11	ALU 12-0772-11	ALU 12-0755-11

Dodatki / Accessories

ŁĄCZNIK PROSTY straight connector	ŁĄCZNIK KĄTOWY 90° angular connector 90°	ŁĄCZNIK POPRZECZNY KĄTOWY angular transverse connector	ŁĄCZNIK KĄTOWY 120° angular connector 120°	ŁĄCZNIK MIĘDZYPROFILOWY TALIA inter-profile TALIA connector	SPRĘŻYNY MONTAŻOWE mounting springs
					
14-3032-02	14-3030-01	14-3038-01	14-3036-01	14-3041-03	14-5001-00

TALIA M4

Profil LED / Profile LED

PL
Profil montażowy sufitowy dla profilu TALIA – do stosowania w systemach wpuszczanych.

EN
Assembly ceiling profile for TALIA profile – to be used in groove mounted systems.

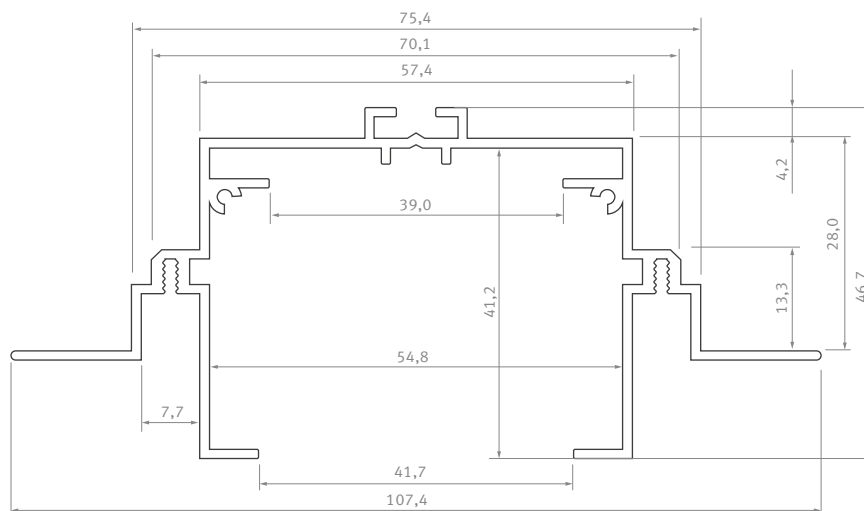

Profil montażowy sufitowy / Mounting profile

Wymiary [mm] / Dimensions [mm]: 1000, 2020, 3000

	BIAŁY (lakierowany) white (lacquered)	CZARNY (lakierowany) black (lacquered)	SREBRNY (anodowany) silver (anodized)
Kolory profili Profile colors			
1,0 m	10-0371-10	10-0545-10	10-0374-10
2,02 m	10-0371-20	10-0545-20	10-0374-20
3,0 m	10-0371-30	10-0545-30	10-0374-30

Zaślepki (aluminium) / End caps (aluminum)

PEŁNE full finish			PROSTE basic finish		
BIAŁY white	CZARNY black	SREBRNY silver	BIAŁY white	CZARNY black	SREBRNY silver
TALIA M4					
ALU 12-0761-11	ALU 12-0792-11	ALU 12-0785-11	ALU 12-0771-11	ALU 12-0782-11	ALU 12-0795-11

Dodatki / Accessories

PROFIL POMOCNICZY ROSET assembly profile ROSET	ŁĄCZNIK MIĘDZYPROFIŁOWY TALIA inter-profile TALIA connector
1 m / 10-0314-10	14-3041-03



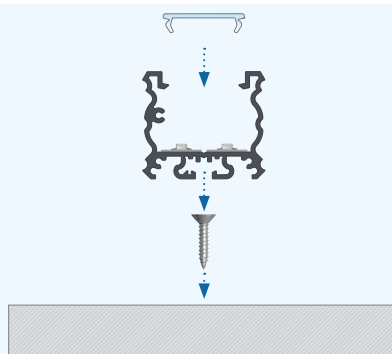

PL

Instrukcja montażu profilu TALIA z kloszem DOUBLE przy pomocy wkrętu montażowego.

EN

Installation instruction for profile TALIA with a DOUBLE cover using mounting screw.

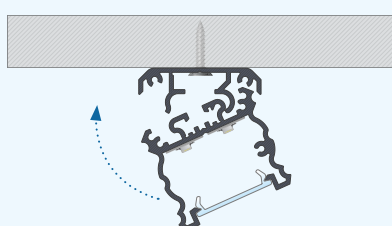
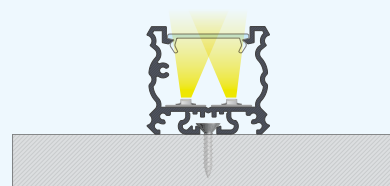

PL

Zasada montażu profilu TALIA z kloszem DOUBLE z wykorzystaniem wkrętu montażowego oraz profilu montażowego TALIA M1.

EN

Installation of TALIA profile with DOUBLE cover using the mounting screw and TALIA M1 mounting profile.

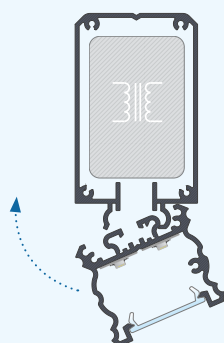
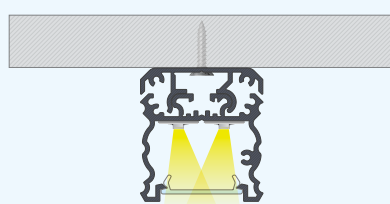

PL

Zasada montażu profilu TALIA z kloszem DOUBLE z wykorzystaniem profilu montażowego TALIA M2 z przeznaczeniem na zasilacz.

EN

Installation of TALIA profile with DOUBLE cover and hidden power supply inside of the mounting profile TALIA M2.

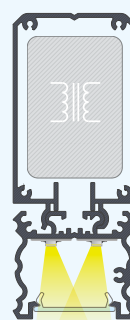

PL

Łączenie profili TALIA za pomocą [1] łącznika prostego lub [2] łącznika kątowego w wyfrezowanym otworze.

EN

Connecting TALIA profiles using [1] straight connector or [2] angular connector in a milled groove.

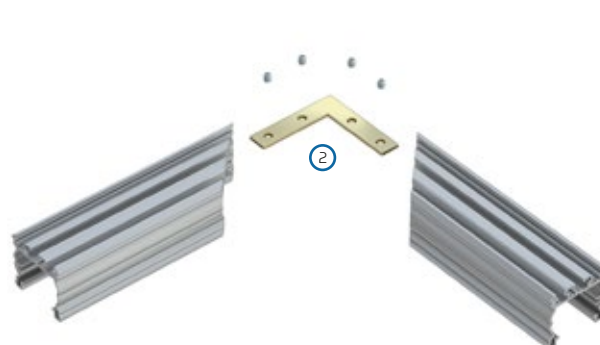

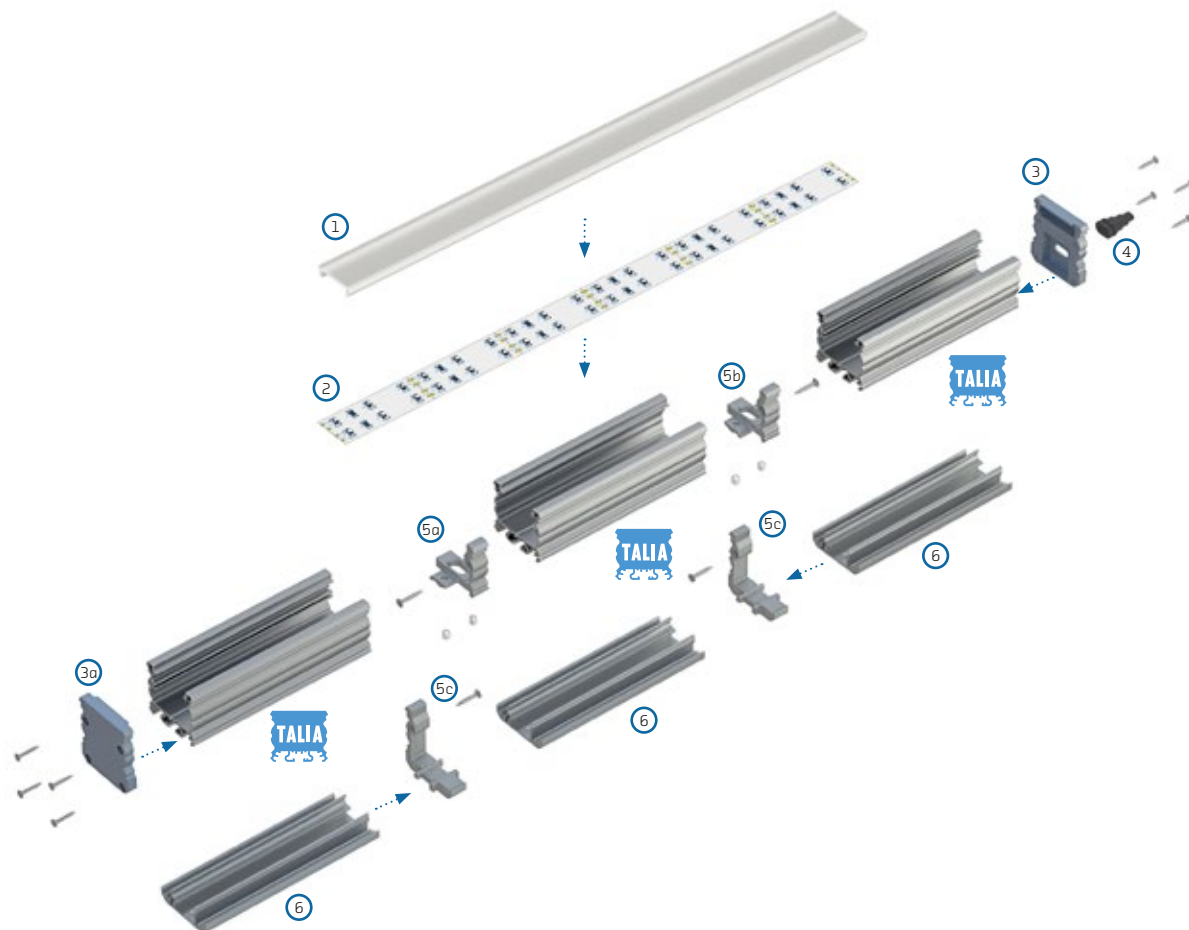

PL

Schemat złożenia elementów systemu oświetleniowego z wykorzystaniem profilu TALIA, [1] klosza DOUBLE, [2] taśm LED, [3] zaślepki TALIA + M1 z otworem, [3a] zaślepki TALIA + M1 bez otworu, [4] dtawnicy, [5a] łącznika TALIA prawego, [5b] łącznika TALIA lewego, [5c] łącznika TALIA M1, [6] profilu montażowego TALIA M1.

EN

Assembly scheme for elements of the lighting system using profile TALIA, [1] DOUBLE cover, [2] LED strips, [3] end cap TALIA + M1 with hole, [3a] end cap TALIA + M1 without hole, [4] cable gland, [5a] right TALIA connector, [5b] left TALIA connector, [5c] connector TALIA M1, [6] TALIA M1 mounting profile.



PL

Zasada montażu systemu profilu TALIA z wykorzystaniem łączników profilowych oraz profilu montażowego TALIA M1.

EN

Assembly of TALIA profile system using profile connectors and mounting profile TALIA M1.

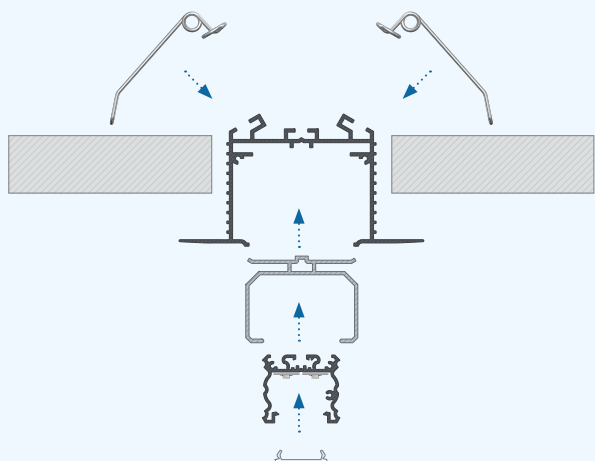

PL

Instrukcja montażu profilu TALIA z wykorzystaniem profilu montażowego TALIA M3 w suficie przy użyciu sprężyn montażowych.

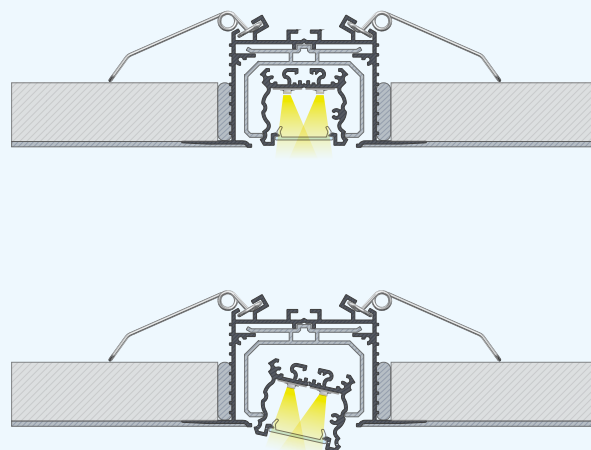

EN

Instruction of assembly of profile TALIA using mounting profile TALIA M3 in the ceiling using mounting springs.

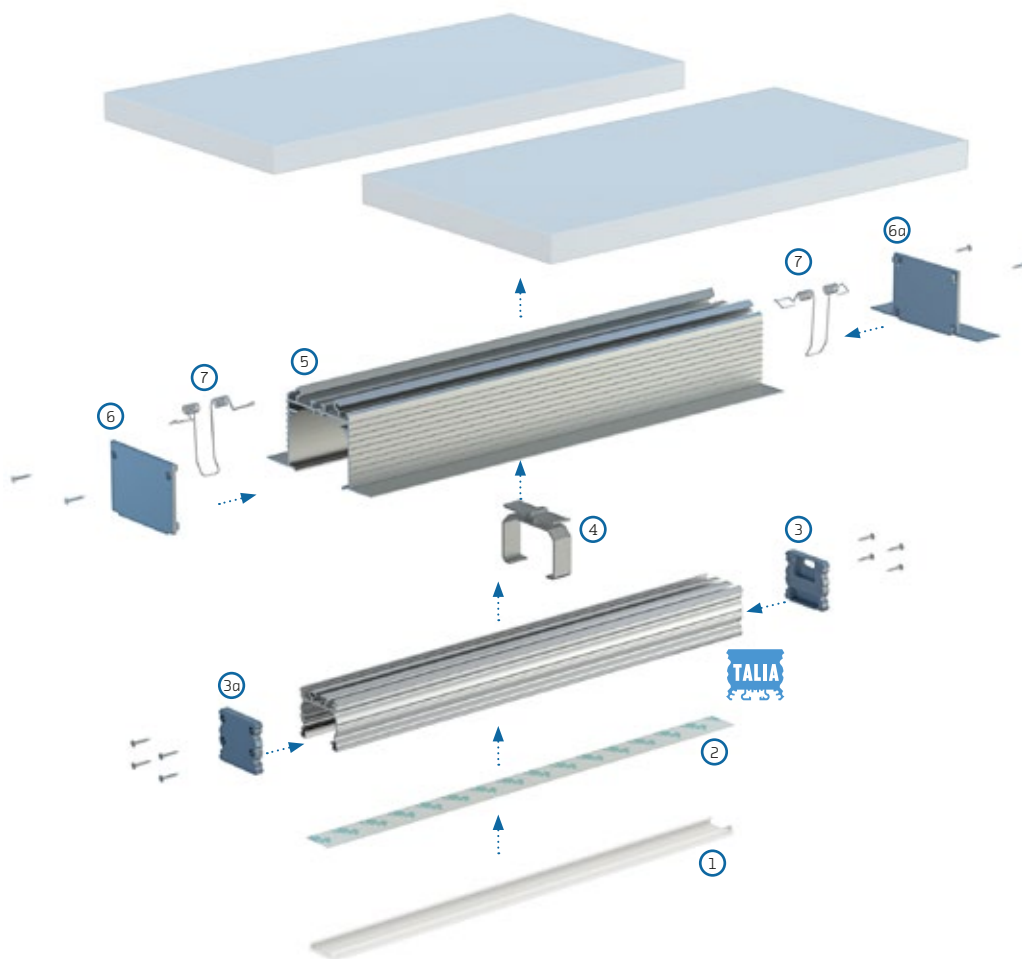

PL

Schemat złożenia elementów systemu oświetleniowego w suficie z wykorzystaniem profilu TALIA, [1] klosza DOUBLE, [2] taśm LED, [3] zaślepki TALIA z otworem, [3a] zaślepki TALIA bez otworu, [4] łącznika międzyprofilowego TALIA, [5] profilu montażowego TALIA M3, [6] zaślepki TALIA M3 z wykończeniem prostym, [6a] zaślepki TALIA M3 z wykończeniem pełnym, [7] sprężyn montażowych.

EN

Assemble scheme for elements of the lighting system in ceiling using profile TALIA, [1] DOUBLE cover, [2] LED strips, [3] end cap TALIA with hole, [3a] end cap TALIA without hole, [4] inter-profile connector TALIA, [5] mounting profile TALIA M3, [6] end cap TALIA M3 with basic finish, [6a] end cap TALIA M3 with full finish, [7] mounting springs.

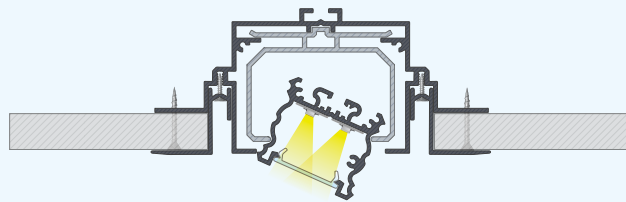
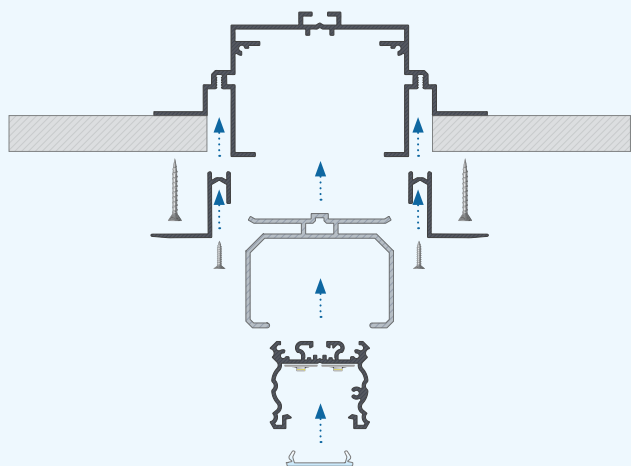

PL

Instrukcja montażu profilu TALIA z wykorzystaniem profilu montażowego TALIA M4 w suficie przy użyciu profilu pomocniczego ROSET, tęcznika międzyprofilowego TALIA oraz wkrętów montażowych.

EN

Instruction of assembly of profile TALIA using mounting profile TALIA M4 in the plasterboard ceiling using assembly profile ROSET, inter-profile connector TALIA and mounting screws.

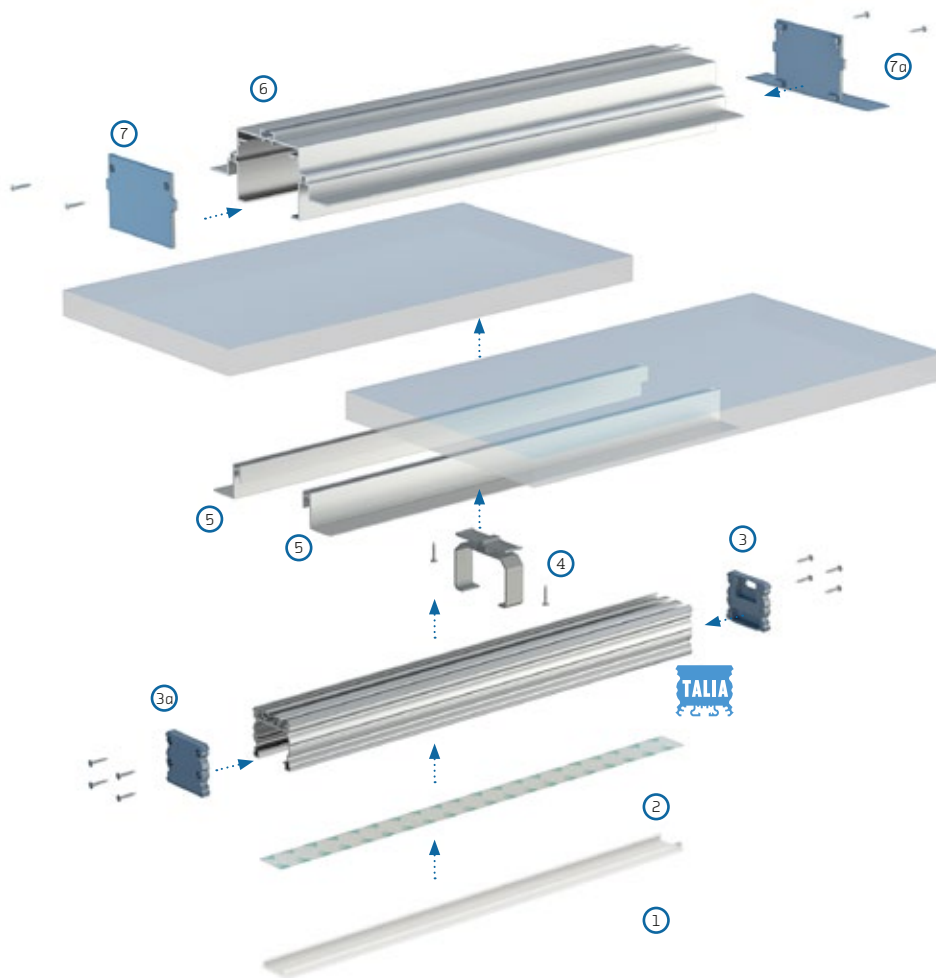

PL

Schemat złożenia elementów systemu oświetleniowego w suficie z wykorzystaniem profilu TALIA, [1] klosza DOUBLE, [2] taśm LED, [3] zaślepki TALIA z otworem, [3a] zaślepki TALIA bez otworu, [4] tęcznika międzyprofilowego TALIA, [5] profilu pomocniczego ROSET, [6] profilu montażowego TALIA M4, [7] zaślepki TALIA M4 z wykończeniem prostym, [7a] zaślepki TALIA M4 z wykończeniem pełnym.

EN

Assemble scheme for elements of the lighting system in ceiling using profile TALIA, [1] DOUBLE cover, [2] LED strips, [3] end cap TALIA with hole, [3a] end cap TALIA without hole, [4] inter-profile connector TALIA, [5] assembly profile ROSET, [6] mounting profile TALIA M4, [7] end cap TALIA M4 with basic finish, [7a] end cap TALIA M4 with full finish.

inTALIA

Profil LED / Profile LED

PL
Profil wpuszczany architektoniczny – do zastosowań biurowych i w pomieszczeniach użyteczności publicznej.

EN
Recessed architectural profile – to be used in office spaces and public utility premises.

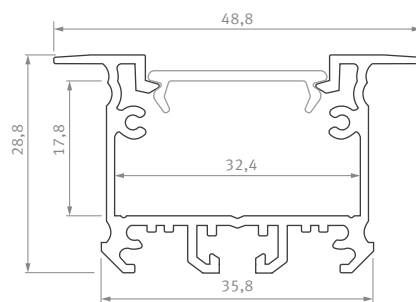

Sposoby montażu /
Assembly methods





inTALIA



Profil LED / Profile LED

Wymiary [mm] / Dimensions (mm): 1000, 2020, 3000

	BIAŁY (lakierowany) white (lacquered)	CZARNY (lakierowany) black (lacquered)	SREBRNY (anodowany) silver (anodized)
Kolory profili Profile colors			
1,0 m	10-0231-10	10-0395-10	10-0234-10
2,02 m	10-0231-20	10-0395-20	10-0234-20
3,0 m	10-0231-30	10-0395-30	10-0234-30
Szerokość taśmy LED [mm] LED strip width (mm)	2 * 12		

Klosze (PMMA) / Covers

Wymiary [mm] / Dimensions (mm): 1000, 2020, 3000

TRANSPARENTNY transparent	MROŻONY frozen	MLECZNY milky	FROSTED MLECZNY milky frosted	CZARNY PMMA black PMMA
DOUBLE				
				
1 m/PMMA 11-2073-10	1 m/PMMA 11-2072-10	1 m/PMMA 11-2071-10	1 m/PMMA 11-2076-10	1 m/PMMA 11-2447-10

Zaślepki (aluminium) / End caps (aluminium)

Z OTWOREM with a hole		
BIAŁY white	CZARNY black	SREBRNY silver
inTALIA		
		
ALU 12-0421-10	ALU 12-0492-10	ALU 12-0425-10

Dodatki / Accessories

ŁĄCZNIK PROSTY straight connector	ŁĄCZNIK KĄTOWY 90° angular connector 90°	ŁĄCZNIK POPRZECZNY KĄTOWY angular transverse connector	ŁĄCZNIK KĄTOWY 120° angular connector 120°
			
14-3032-02	14-3030-01	14-3038-01	14-3036-01
ŁĄCZNIK MIĘDZYPROFIŁOWY TALIA inter-profile TALIA connector	SPRĘŻYNY MONTAŻOWE mounting springs	DŁAWNICA cable gland	
			
14-3041-03	14-5001-00	*B 14-5046-00 *W 14-5046-01	

* B CZARNY black; * W BIAŁY white

LUMINES[®]
LIGHTING

inTALIA
LUMINES



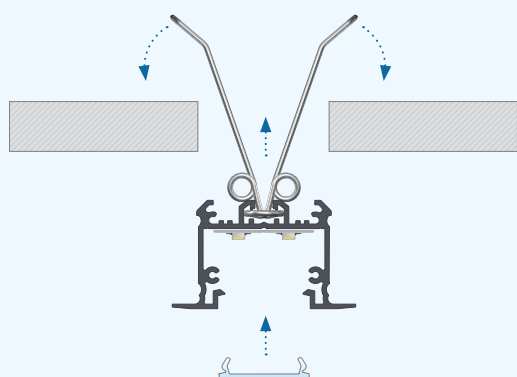

PL

Instrukcja montażu profilu inTALIA z kloszem DOUBLE przy pomocy sprężyn montażowych.

EN

Installation instruction for profile inTALIA with a DOUBLE cover using mounting springs.

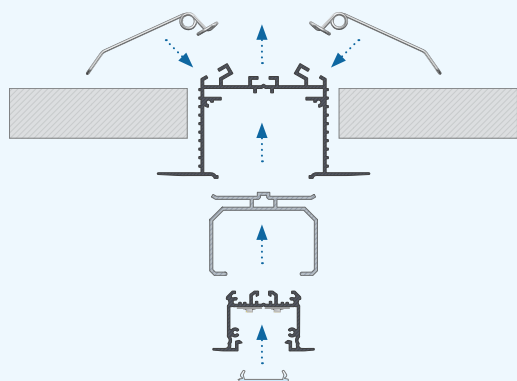
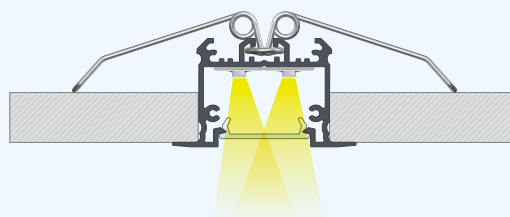

PL

Instrukcja montażu profilu inTALIA z kloszem DOUBLE przy użyciu łącznika międzyprofilowego TALIA, profilu montażowego TALIA M3 oraz sprężyn montażowych.

EN

Instruction of assembly of profile inTALIA with DOUBLE cover using inter-profile TALIA connector, mounting profile TALIA M3 and mounting springs.

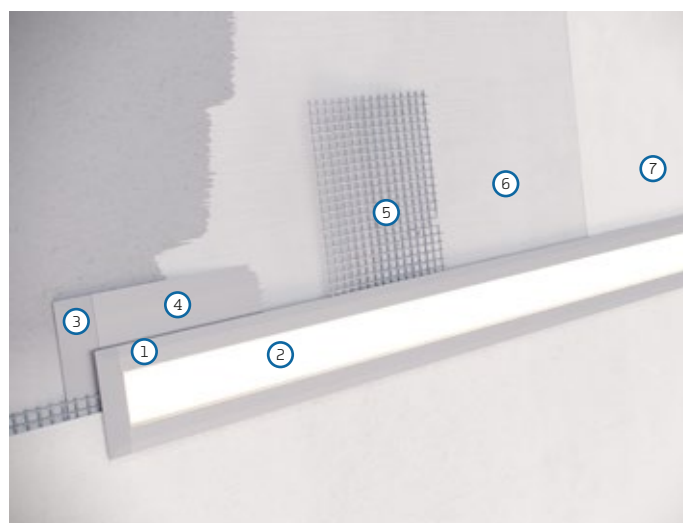
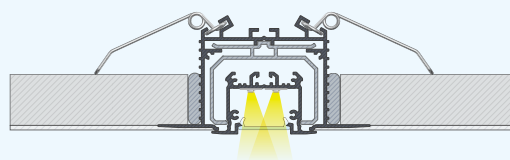

PL

Oświetlenie sufitowe wykonane z profilu inTALIA.

1. Profil inTALIA.
2. Klosz DOUBLE.
3. Zaślepka pełna.
4. TALIA M3.
5. Siatka.
6. Gips.
7. Farba.

EN

Ceiling lighting made of inTALIA profile.

1. Profile inTALIA.
2. DOUBLE cover.
3. Full finish end cap.
4. TALIA M3.
5. Net.
6. Plaster.
7. Paint.

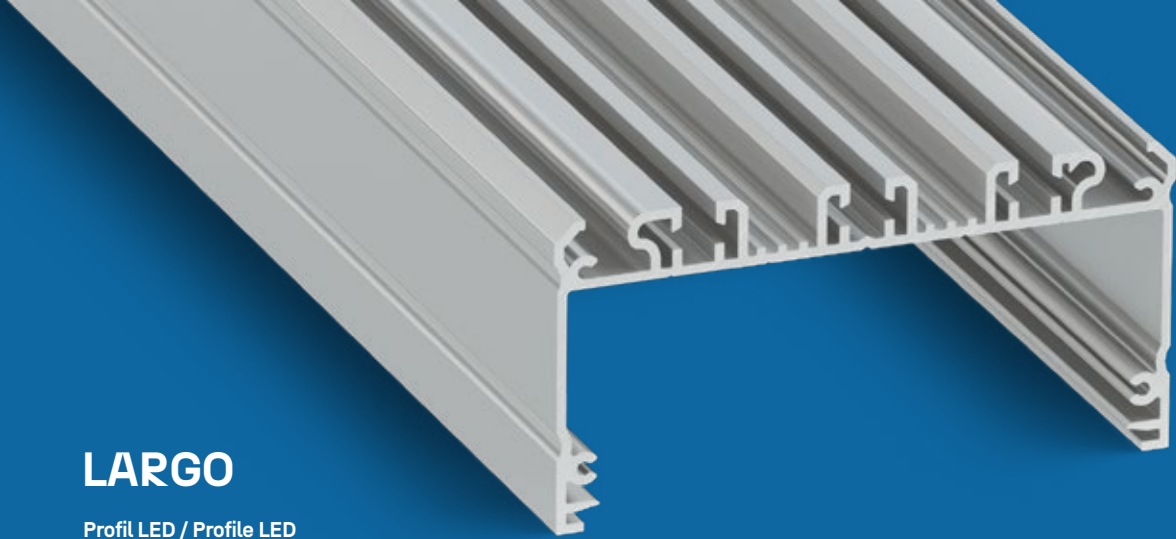

LARGO

Profil LED / Profile LED

PL

Profil nawierzchniowy – do montażu złożonych systemów oświetlenia z możliwością wykorzystania do 6 odcinków taśm LED. Do stosowania w budynkach komercyjnych i obiektach użyteczności publicznej.

EN

Surface profile. For the assembly of complex line lighting systems with the possibility to use up to 6 of LED strips. To be used in commercial facilities and public utility premises.

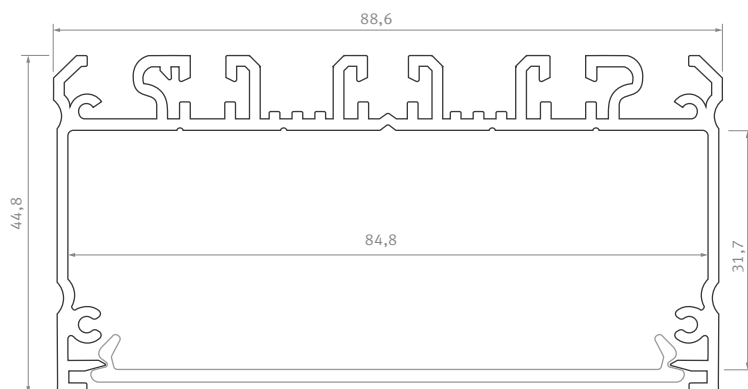

Sposoby montażu /
Assembly methods

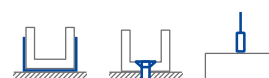



LARGO

LARGO
SZCZEGÓŁY



Profil LED / Profile LED

Wymiary [mm] / Dimensions (mm): 1000, 2020, 3000





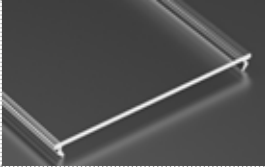

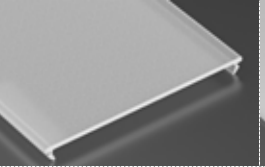
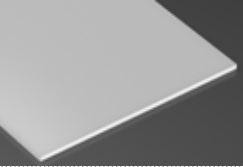
Kolory profili Profile colors	BIAŁY (lakierowany) white (lacquered)	CZARNY (lakierowany) black (lacquered)	SREBRNY (anodowany) silver (anodized)
			
1,0 m	10-0281-10	10-0695-10	10-0284-10
2,02 m	10-0281-20	10-0705-20	10-0284-20
3,0 m	10-0281-30	10-0715-30	10-0284-30
Szerokość taśmy LED [mm] LED strip width [mm]	6 × 12		

Klosze (PMMA) / Covers

Wymiary [mm] / Dimensions (mm): 1000, 2020, 3000

TRANSPARENTNY transparent	MLECZNY milky	FROSTED MLECZNY milky frosted	MLECZNY milky
SUPER WIDE		SUPER WIDE PLEXI	
			
1 m/PMMA 11-2093-10	1 m/PMMA 11-2091-10	1 m/PMMA 11-2096-10	1 m/PLEXI 11-3091-10

Zaślepki (aluminium) / End caps (aluminum)

Z OTWOREM with a hole			BEZ OTWORU without a hole		
BIAŁY white	CZARNY black	SREBRNY silver	BIAŁY white	CZARNY black	SREBRNY silver
LARGO					
					
ALU 12-0431-10	ALU 12-0422-10	ALU 12-0515-10	ALU 12-0431-11	ALU 12-0431-11	ALU 12-0515-11

Dodatki / Accessories

PROFIL MONTAŻOWY LARGO M1 mounting profile LARGO M1 	PROFIL MONTAŻOWY LARGO M2 mounting profile LARGO M2 	PROFIL MONTAŻOWY LARGO M3 mounting profile LARGO M3 	PROFIL MONTAŻOWY LARGO M4 mounting profile LARGO M4 	ŁĄCZNIK PROSTY straight connector 	ŁĄCZNIK KĄTOWY 90° angular connector 90° 
1 m/ 10-0244-10	1 m/ 10-0254-10	1 m/ 10-0264-10	1 m/ 10-0274-10	14-3032-02	14-3030-01
ŁĄCZNIK POPRZECZNY KĄTOWY angular transverse connector 	ŁĄCZNIK KĄTOWY 120° angular connector 120° 	DŁAWNICA cable gland 	UCHWYT NA PRZEWÓD cable 5 mm holder 	ZAWIESIA pendants 	
14-3038-01	14-3036-01	*B 14-5046-00 *W 14-5046-01	*T 14-7067-00 *B 14-7067-02	*S 14-2011-02 *B 14-2076-00 *W 14-2075-00	

* S SREBRNY silver; * B CZARNY black; * T TRANSPARENTNY transparent; * W BIAŁY white

1  ODBIÓ
BAGGA

LARGO
LUMINES



R BAGAŽU
GE RECLAIM



LARGO M1

Profil LED / Profile LED

PL

Profil montażowy do profilu LARGO – do podstawowego montażu długich systemów oświetlenia. Do stosowania z wcześniej uzbrojonymi w taśmy LED, długimi odcinkami profili.

EN

Assembly profile for LARGO profile – for the basic assembly of long lighting systems. To be used with long profile section equipped with LED strips.

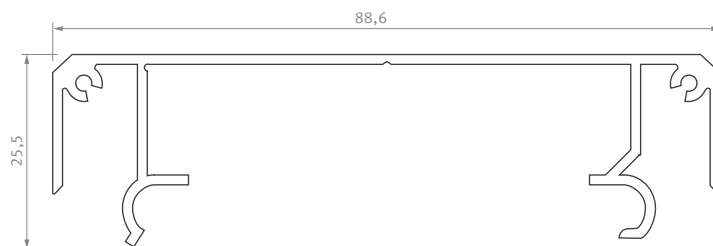



Profil montażowy podstawowy / Mounting profile

Wymiary [mm] / Dimensions [mm]: 1000, 2020, 3000

	BIAŁY (lakierowany) white (lacquered)	CZARNY (lakierowany) black (lacquered)	SREBRNY (anodowany) silver (anodized)
Kolory profili Profile colors			
1,0 m	10-0241-10	10-0425-10	10-0244-10
2,02 m	10-0241-20	10-0695-20	10-0244-20
3,0 m	10-0241-30	10-0425-30	10-0244-30

Zaślepki (aluminium) / End caps (aluminum)

Z OTWOREM with a hole			BEZ OTWORU without a hole		
BIAŁY white	CZARNY black	SREBRNY silver	BIAŁY white	CZARNY black	SREBRNY silver
LARGO M1					
					
ALU 12-0441-10	ALU 12-0412-10	ALU 12-0445-10	ALU 12-0441-11	ALU 12-0412-11	ALU 12-0445-11
LARGO M1 + LARGO					
					
ALU 12-0451-10	ALU 12-0402-10	ALU 12-0455-10	ALU 12-0451-11	ALU 12-0902-11	ALU 12-0455-11

LARGO M2

Profil LED / Profile LED

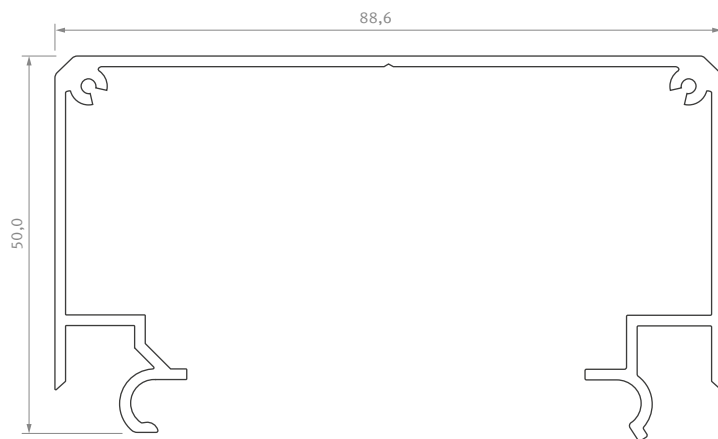

PL
Profil montażowy zasilaczowy dla profilu LARGO – do estetycznego ukrycia zasilacza przy montażu nawierzchniowym.

EN
Assembly power supply profile for LARGO profile. For the aesthetic hiding of the power supply in surface assembly.



Profil montażowy zasilaczowy / Mounting profile (for power supply)

Wymiary [mm] / Dimensions [mm]: 1000, 2020, 3000

	BIAŁY (lakierowany) white (lacquered)	CZARNY (lakierowany) black (lacquered)	SREBRNY (anodowany) silver (anodized)
Kolory profili Profile colors			
1,0 m	10-0251-10	10-0735-10	10-0254-10
2,02 m	10-0251-20	10-0605-20	10-0254-20
3,0 m	10-0251-30	10-0435-30	10-0254-30

Zaślepki (aluminium) / End caps (aluminum)

Z OTWOREM with a hole			BEZ OTWORU without a hole		
BIAŁY white	CZARNY black	SREBRNY silver	BIAŁY white	CZARNY black	SREBRNY silver
LARGO M2					
					
ALU 12-0461-10	ALU 12-0432-10	ALU 12-0465-10	ALU 12-0461-11	ALU 12-0422-11	ALU 12-0465-11
LARGO M2 + LARGO					
					
ALU 12-1021-10	ALU 12-0902-10	ALU 12-1025-10	ALU 12-1021-11	ALU 12-0000-14	ALU 12-1025-11

LARGO M3

Profil LED / Profile LED

PL

Profil konstrukcyjny sufitowy do profilu LARGO – do bezpośredniego montażu wpuszczonego w systemach gipsowo-kartonowych.

EN

Constructional ceiling profile for LARGO profile – for the direct assembly groove mounted in drywall systems.

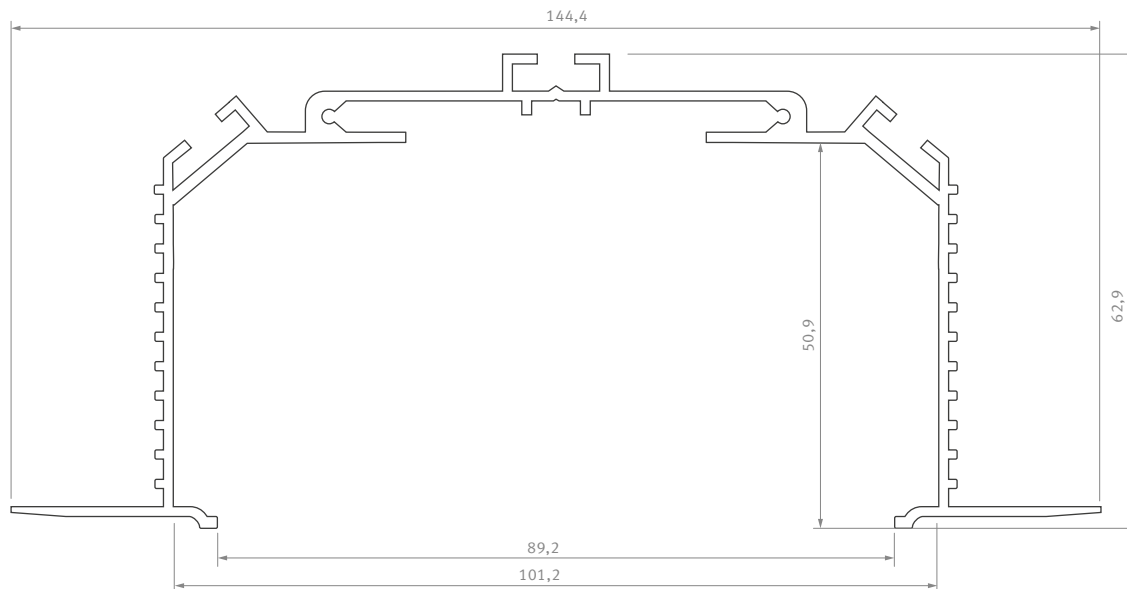

Profil montażowy sufitowy / Mounting profile

Wymiary [mm] / Dimensions (mm): 1000, 2020, 3000

Kolory profili Profile colors	BIAŁY (lakierowany) white (lacquered)	CZARNY (lakierowany) black (lacquered)	SREBRNY (anodowany) silver (anodized)
	1,0 m	10-0261-10	10-0435-10
2,02 m	10-0261-20	10-0435-20	10-0264-20
3,0 m	10-0261-30	10-0435-30	10-0264-30

Zaślepki (aluminium) / End caps (aluminum)

PEŁNE full finish			PROSTE basic finish		
BIAŁY white	CZARNY black	SREBRNY silver	BIAŁY white	CZARNY black	SREBRNY silver
LARGO M3					
ALU 12-0471-11	ALU 12-0432-11	ALU 12-0475-11	ALU 12-0481-11	ALU 12-0442-11	ALU 12-0485-11

Dodatki / Accessories

ŁĄCZNIK PROSTY straight connector	ŁĄCZNIK KĄTOWY 90° angular connector 90°	ŁĄCZNIK POPRZECZNY KĄTOWY angular transverse connector	ŁĄCZNIK KĄTOWY 120° angular connector 120°	ŁĄCZNIK MIĘDZYPROFIŁOWY LARGO inter-profile LARGO connector	SPRĘŻYNY MONTAŻOWE mounting springs
14-3032-02	14-3030-01	14-3038-01	14-3036-01	14-3040-03	14-5001-00

LARGO M4

Profil LED / Profile LED

PL
Profil montażowy sufitowy do profilu LARGO – do montażu wpuszczanego. Do stosowania w budynkach użyteczności publicznej i pomieszczeniach komercyjnych.

EN
Assembly ceiling profile for LARGO profile – for the groove mounted assembly. To be used in commercial spaces and public utility premises.

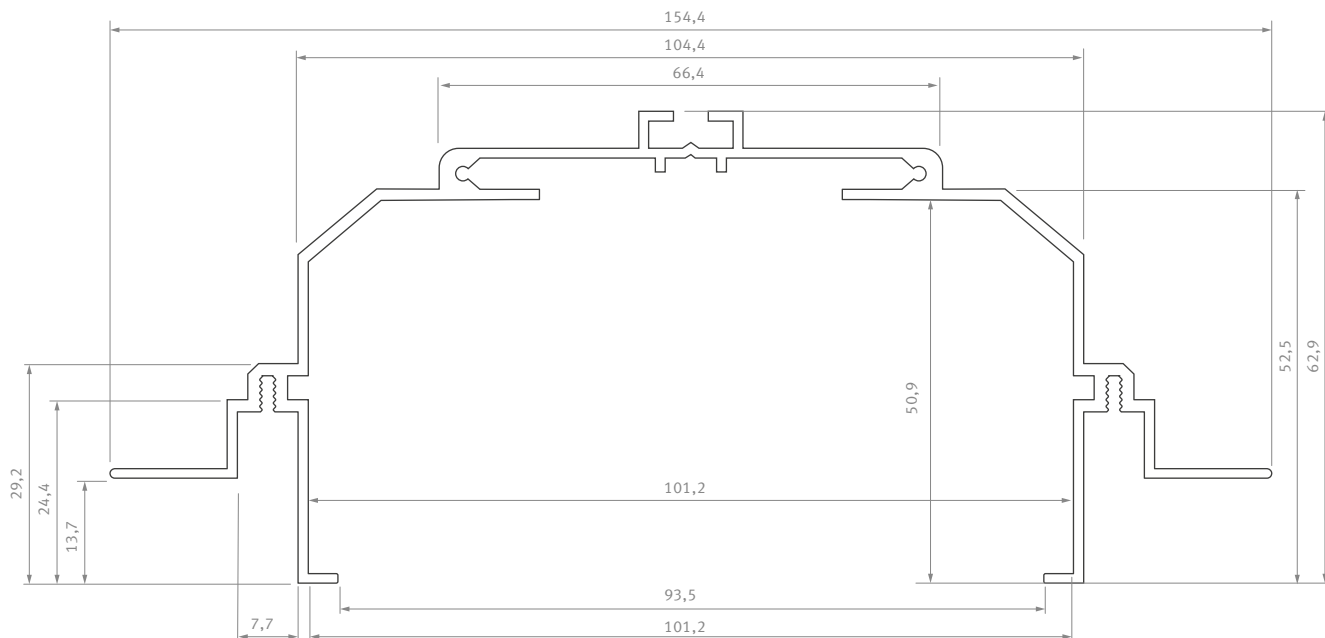

Profil montażowy sufitowy / Mounting profile

Wymiary [mm] / Dimensions [mm]: 1000, 2020, 3000

Kolory profili Profile colors	BIAŁY (lakierowany) white (lacquered)	CZARNY (lakierowany) black (lacquered)	SREBRNY (anodowany) silver (anodized)
	1,0 m	10-0271-10	10-0445-10
2,02 m	10-0271-20	10-0445-20	10-0274-20
3,0 m	10-0271-30	10-0445-30	10-0274-30

Zaślepki (aluminium) / End caps (aluminum)

PEŁNE full finish			PROSTE basic finish		
BIAŁY white	CZARNY black	SREBRNY silver	BIAŁY white	CZARNY black	SREBRNY silver
LARGO M4					
ALU 12-0491-11	ALU 12-0452-11	ALU 12-0495-11	ALU 12-0501-11	ALU 12-0462-11	ALU 12-0505-11

Dodatki / Accessories

ŁĄCZNIK PROSTY straight connector	ŁĄCZNIK KĄTOWY 90° angular connector 90°	ŁĄCZNIK POPRZECZNY KĄTOWY angular transverse connector	ŁĄCZNIK KĄTOWY 120° angular connector 120°	PROFIL POMOCNICZY ROSET assembly profile ROSET	ŁĄCZNIK MIĘDZYPROFILOWY LARGO inter-profile LARGO connector
14-3032-02	14-3030-01	14-3038-01	14-3036-01	1 m/ 10-0314-10	14-3040-03

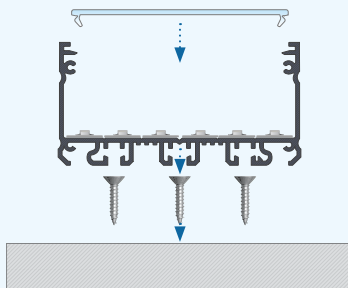

PL

Instrukcja montażu profilu LARGO z kloszem SUPER WIDE przy pomocy wkrętów montażowych.

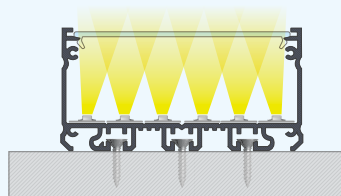

EN

Installation instructions for profile LARGO with a SUPER WIDE cover using mounting screws.

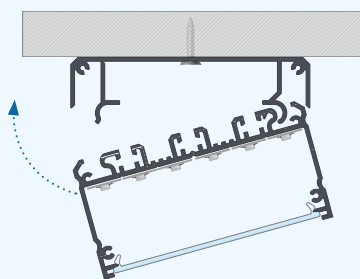

PL

Zasada montażu systemu profilu LARGO z kloszem SUPER WIDE z wykorzystaniem profilu montażowego LARGO M1.

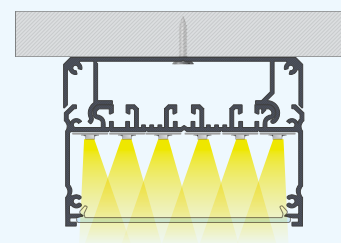

EN

Assembly of profile LARGO system with SUPER WIDE cover using mounting profile LARGO M1.

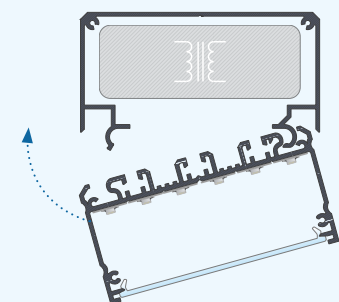

PL

Zasada montażu profilu LARGO z kloszem SUPER WIDE, z wykorzystaniem profilu montażowego LARGO M2, z przeznaczeniem na zasilacz.

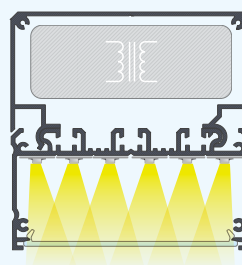

EN

Assembly of LARGO profile with SUPER WIDE cover using mounting profile LARGO M2 for hiding the power supply inside.

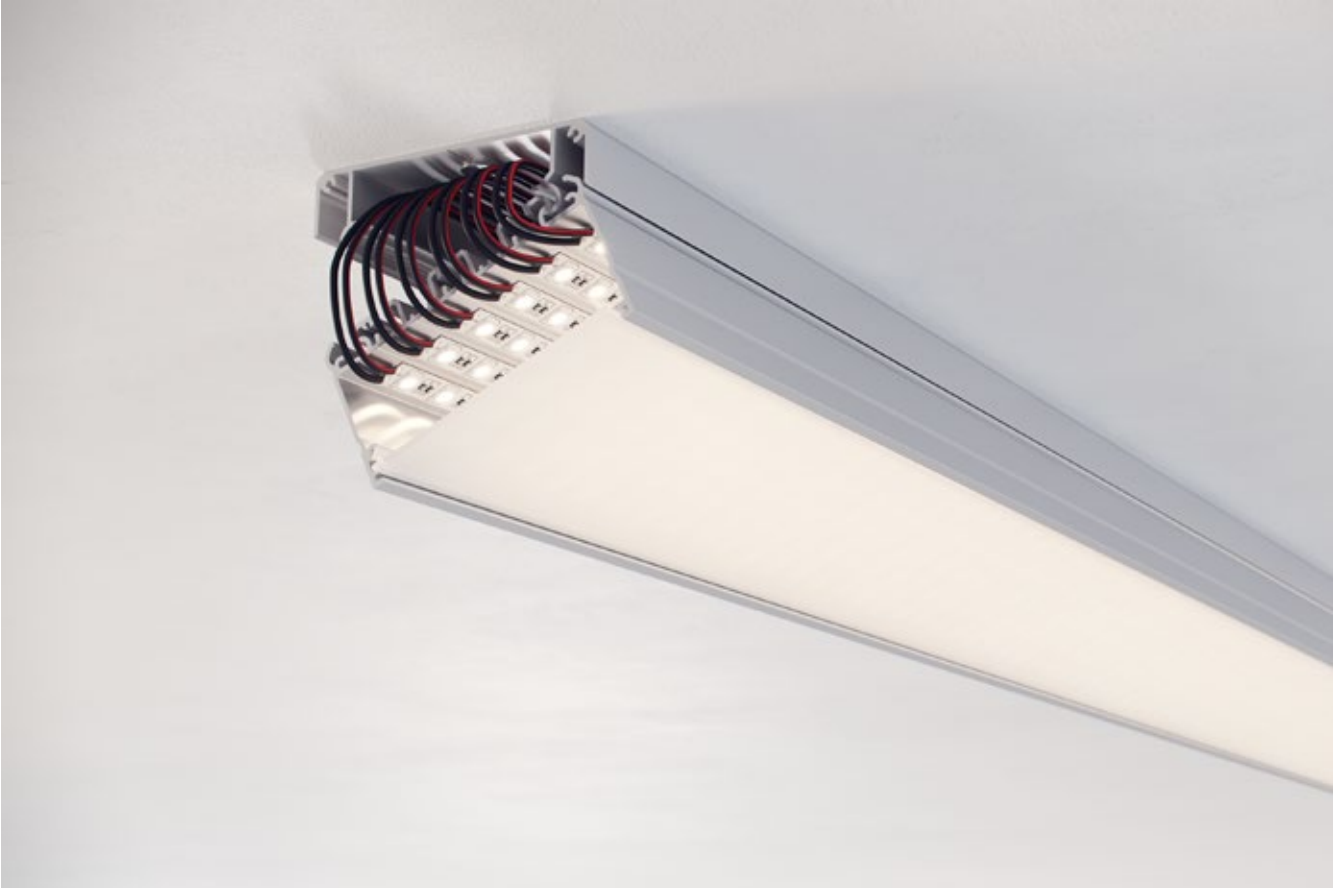

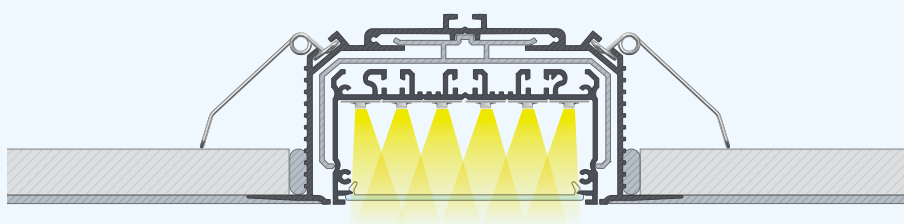
**PL**

Efekt końcowy montażu systemu profilu LARGO z kloszem SUPER WIDE oraz profilem montażowym LARGO M3 wraz ze sprężynami montażowymi.

EN

End result of assembly of profile LARGO with SUPER WIDE cover and mounting profile LARGO M3 with mounting springs.

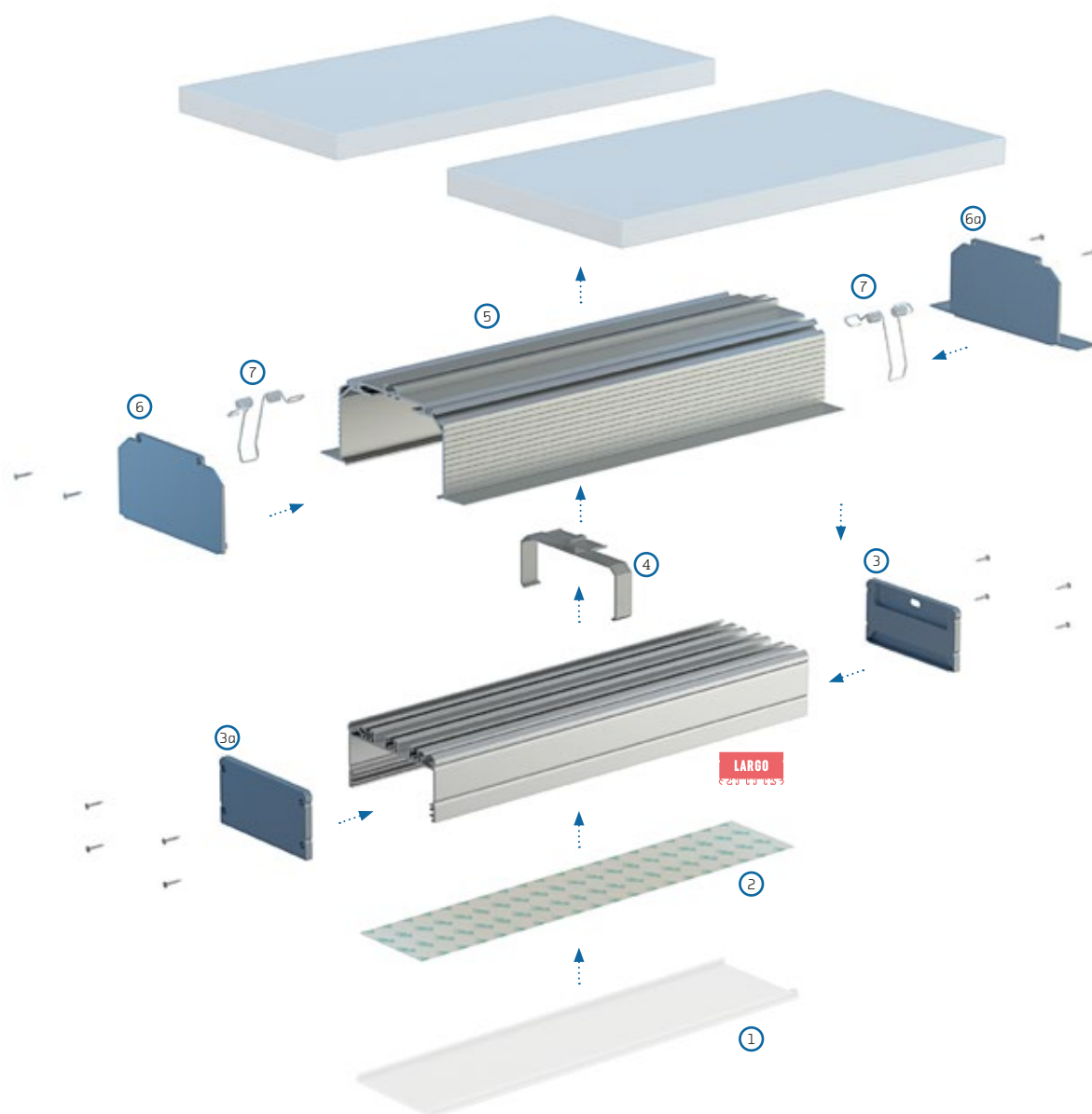
**PL**

Schemat złożenia elementów systemu oświetleniowego w suficie z wykorzystaniem profilu LARGO (1) klosza SUPER WIDE, (2) taśm LED, (3) zaślepki LARGO z otworem, (3a) zaślepki LARGO bez otworu, (4) łącznika międzyprofilowego LARGO, (5) profilu montażowego LARGO M3, (6) zaślepki LARGO M3 z wykończeniem prostym, (6a) zaślepki LARGO M3 z wykończeniem pełnym, (7) sprężyn montażowych.

EN

Assemble scheme for elements of the lighting system in ceiling using profile LARGO, (1) SUPER WIDE cover, (2) LED strips, (3) end cap LARGO with hole, (3a) end cap LARGO without hole, (4) inter-profile connector LARGO, (5) mounting profile LARGO M3, (6) end cap LARGO M3 with basic finish, (6a) end cap LARGO M3 with full finish, (7) mounting springs.

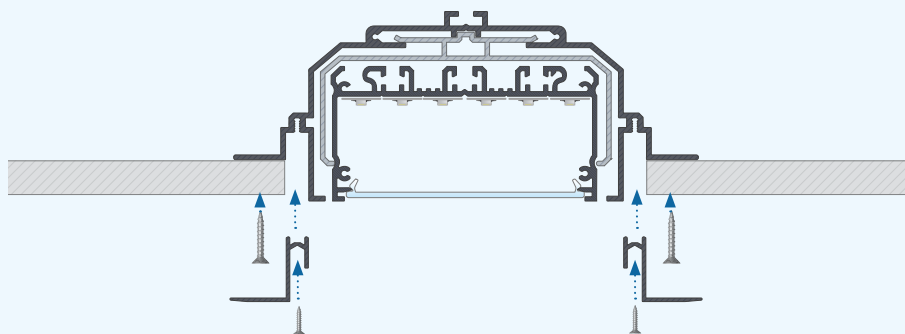

PL

Zasada montażu systemu profilu LARGO z kloszem SUPER WIDE z wykorzystaniem profilu montażowego LARGO M4, łącznika międzyprofilowego LARGO oraz profilu pomocniczego ROSET.

EN

Assembly of LARGO profile with SUPER WIDE cover using mounting profile LARGO M4, inter-profile connector LARGO and assembly profile ROSET.

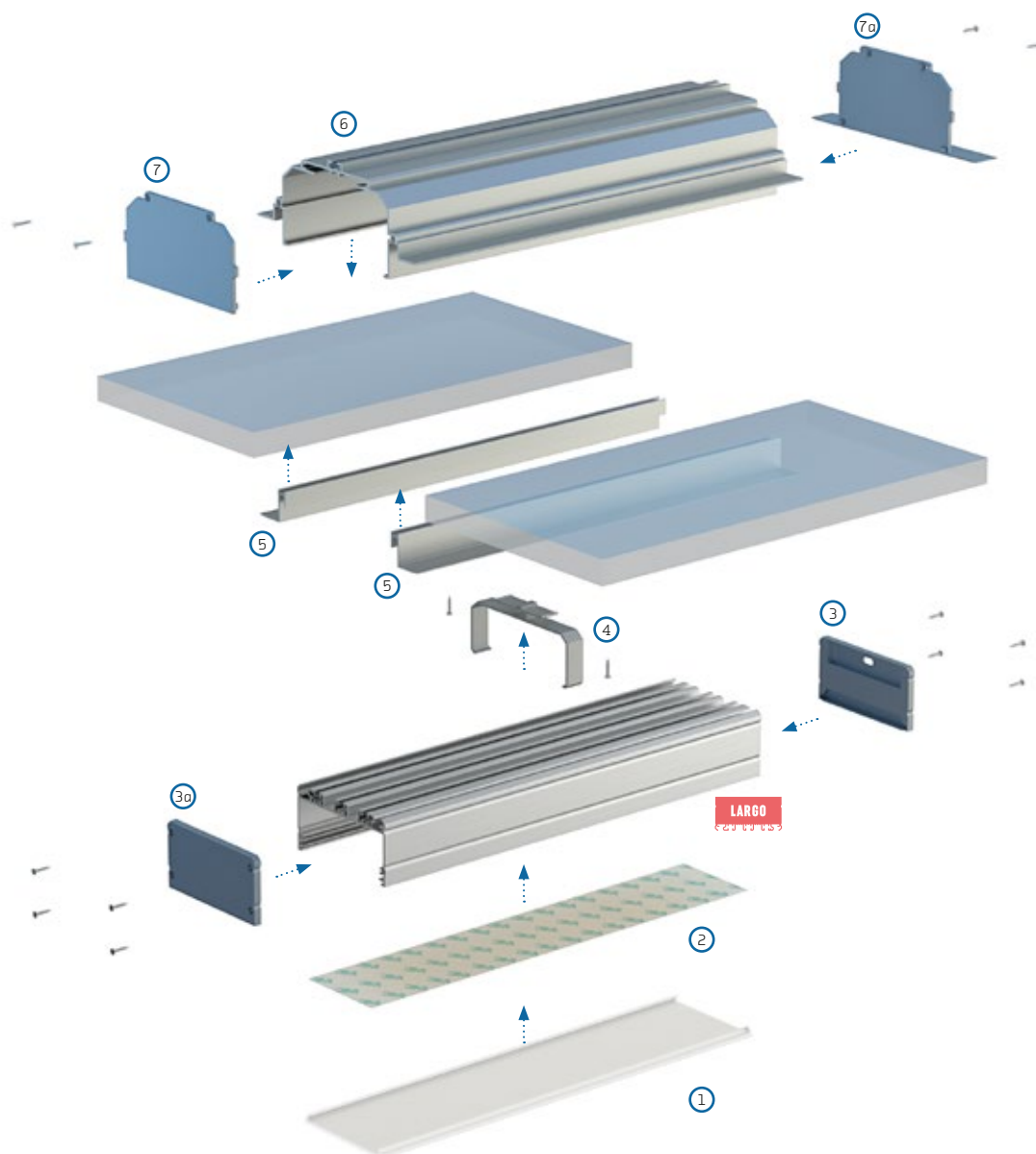

PL

Schemat złożenia elementów systemu oświetleniowego w suficie z wykorzystaniem profilu LARGO, (1) klosza SUPER WIDE, (2) taśm LED, (3) zaślepki LARGO z otworem, (3a) zaślepki LARGO bez otworu, (4) łącznika międzyprofilowego LARGO, (5) profilu pomocniczego ROSET, (6) profilu montażowego LARGO M4, (7) zaślepki LARGO M4 z wykończeniem prostym, (7a) zaślepki LARGO M4 z wykończeniem pełnym.

EN

Assemble scheme for elements of the lighting system in ceiling using profile LARGO, (1) SUPER WIDE cover, (2) LED strips, (3) end cap LARGO with hole, (3a) end cap LARGO without hole, (4) inter-profile connector LARGO, (5) assembly profile ROSET, (6) mounting profile LARGO M4, (7) end cap LARGO M4 with basic finish, (7a) end cap LARGO M4 with full finish.

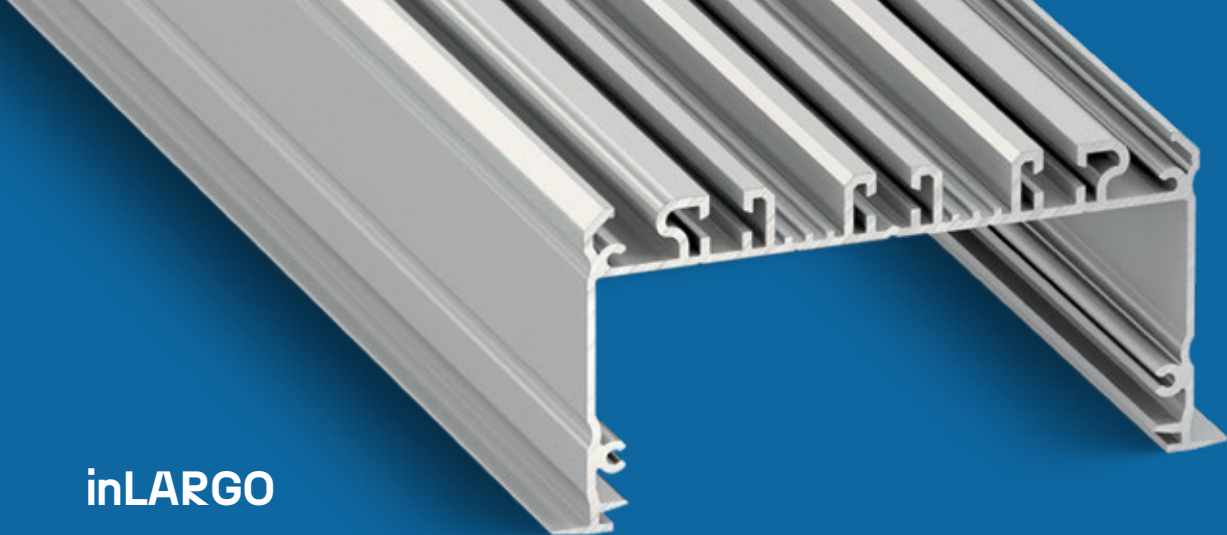

inLARGO

Profil LED / Profile LED

PL

Profil wpuszczany do budowy sześćo-taśmowych systemów oświetleniowych – do stosowania w przestrzeniach użyteczności publicznej i budynkach komercyjnych.

EN

Recessed profile for the construction of six LED strips lighting systems. To be used in commercial facilities and public utility premises.

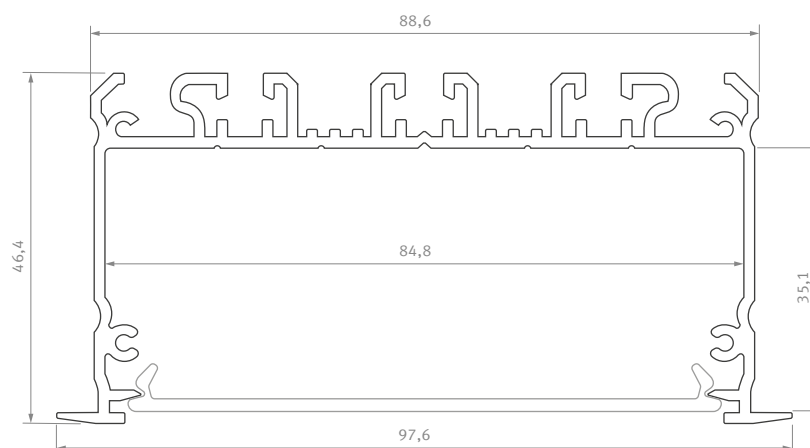

Sposoby montażu /
Assembly methods





inLARGO



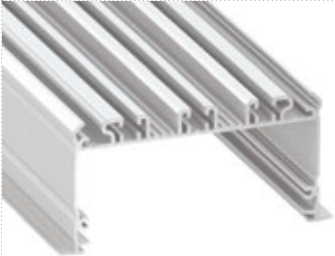

Profil LED / Profile LED

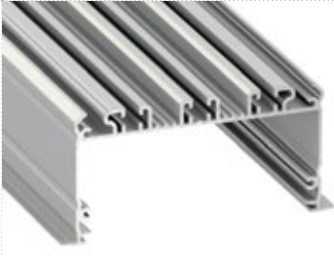
Wymiary [mm] / Dimensions [mm]: 1000, 2020, 3000

Kolory profili Profile colors	BIAŁY (lakierowany) white (lacquered)	CZARNY (lakierowany) black (lacquered)	SREBRNY (anodowany) silver (anodized)
			
1,0 m	10-0211-10	10-0665-10	10-0214-10
2,02 m	10-0211-20	10-0675-20	10-0214-20
3,0 m	10-0211-30	10-0705-30	10-0214-30
Szerokość taśmy LED [mm] LED strip width [mm]	6 × 12		

Klosze (PMMA) / Covers

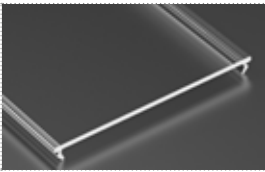
Wymiary [mm] / Dimensions [mm]: 1000, 2020, 3000

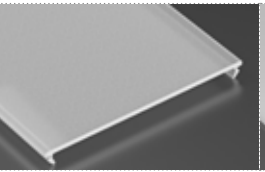
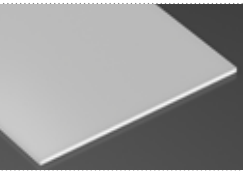
TRANSPARENTNY transparent	MLECZNY milky	FROSTED MLECZNY milky frosted	MLECZNY milky
SUPER WIDE		SUPER WIDE PLEXI	
			
1 m/PMMA 11-2093-10	1 m/PMMA 11-2091-10	1 m/PMMA 11-2096-10	1 m/PLEXI 11-3091-10

Zaślepki (aluminium) / End caps (aluminum)

Z OTWOREM with a hole			
BIAŁY white	CZARNY black	SREBRNY silver	
inLARGO			
			
ALU 12-0401-10	ALU 12-0000-10	ALU 12-0405-10	

Dodatki / Accessories

PROFIL MONTAŻOWY LARGO M3 mounting profile LARGO M3  1 m/ 10-0264-10	PROFIL MONTAŻOWY LARGO M4 mounting profile LARGO M4  1 m/ 10-0274-10	ŁĄCZNIK MIĘDZYPROFIŁOWY LARGO inter-profile LARGO connector  14-3040-03	SPRĘŻYNY MONTAŻOWE mounting springs  14-5001-00	ŁĄCZNIK PROSTY straight connector  14-3032-02
ŁĄCZNIK POPRZECZNY KĄTOWY angular transverse connector  14-3038-01	ŁĄCZNIK KĄTOWY 90° angular connector 90°  14-3030-01	ŁĄCZNIK KĄTOWY 120° angular connector 120°  14-3036-01	DŁAWNICA cable gland  *B 14-5046-00 *W 14-5046-01	

* B CZARNY black; * W BIAŁY white



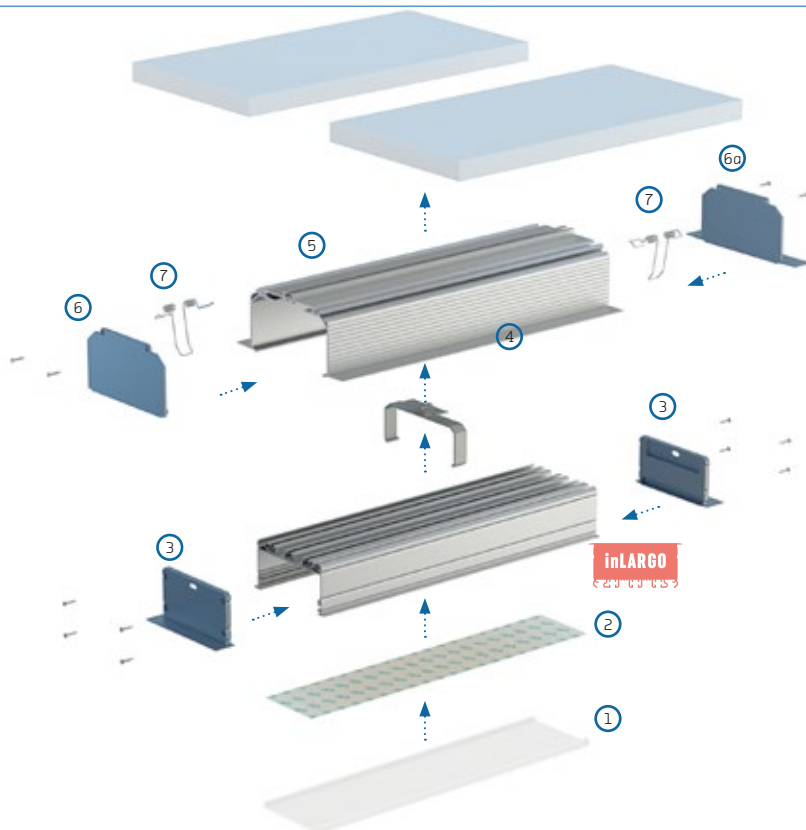

PL

Schemat złożenia elementów systemu oświetleniowego w suficie z wykorzystaniem profilu inLARGO (1) klosza SUPER WIDE, (2) taśm LED, (3) zaślepek inLARGO z otworem, (4) łącznika międzyprofilowego LARGO, (5) profilu montażowego LARGO M3, (6) zaśleпки LARGO M3 z wykończeniem prostym, (6a) zaśleпки LARGO M3 z wykończeniem pełnym, (7) sprężyn montażowych.

EN

Assemble scheme for elements of the lighting system in ceiling using profile inLARGO (1), SUPER WIDE cover, (2) LED strips, (3) end caps inLARGO with holes, (4) inter-profile connector LARGO, (5) mounting profile LARGO M3, (6) end cap LARGO M3 with basic finish, (6a) end cap LARGO M3 with full finish, (7) mounting springs.

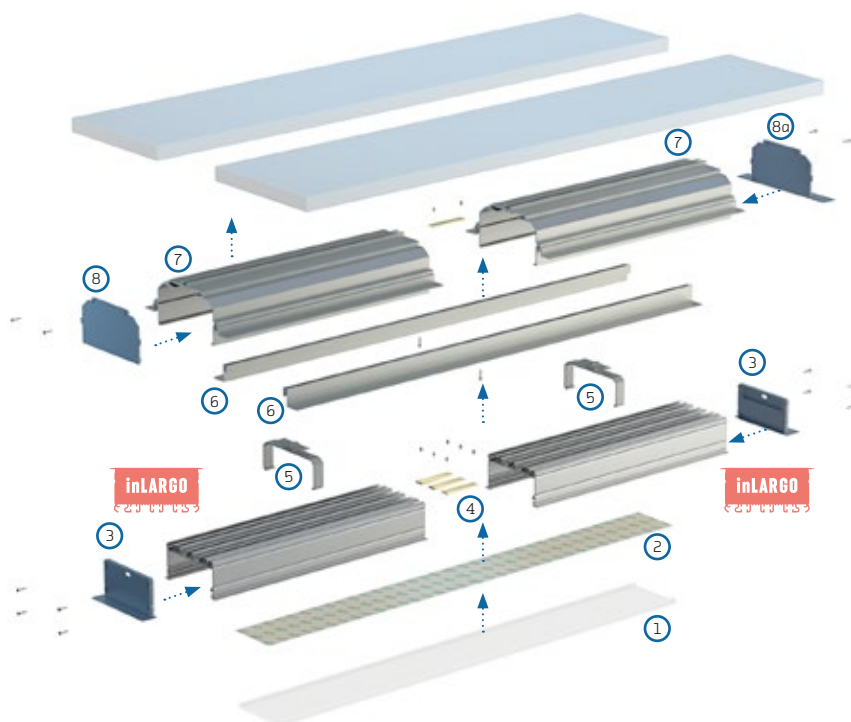

PL

Schemat złożenia elementów systemu oświetleniowego w suficie z wykorzystaniem profilu inLARGO (1) klosza SUPER WIDE, (2) taśm LED, (3) zaślepek inLARGO z otworem, (4) łączników prostych, (5) łączników międzyprofilowych LARGO, (6) profili pomocniczych ROSET, (7) profili montażowych LARGO M4, (8) zaśleпки LARGO M4 z wykończeniem prostym, (8a) zaśleпки LARGO M4 z wykończeniem pełnym.

EN

Assemble scheme for elements of the lighting system in ceiling using profile inLARGO (1) SUPER WIDE cover, (2) LED strips, (3) end caps inLARGO with holes, (4) straight connectors, (5) inter-profile LARGO connectors, (6) assembly profiles ROSET, (7) mounting profiles LARGO M4, (8) end cap LARGO M4 with basic finish, (8a) end cap LARGO M4 with full finish.

NEW
2023

FALCO

Profil LED / Profile LED

PL

Pojedynczy profil LED do instalacji między dwoma płytami GK. Pozwala na szybki montaż przy zastosowaniu wkrętów oraz wykończenie gładzi szpachlową bez konieczności użycia siatki montażowej.

EN

Single LED profile for installation between two plasterboard sheets. Allows for fast installation using screws and finishing with plaster without the need for a mounting mesh.

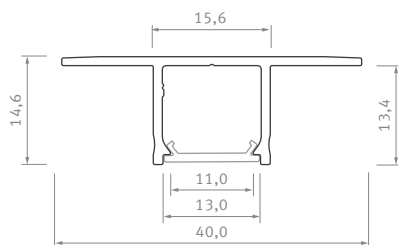

FALCO

Sposoby montażu /
Assembly methods





FALCO

FALCO



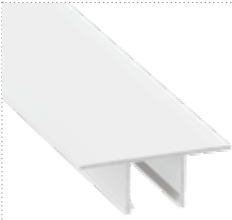

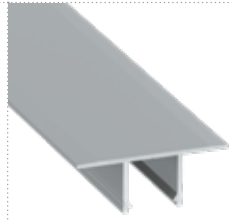
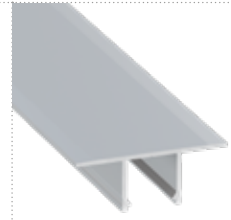

Profil LED / Profile LED

Wymiary [mm] / Dimensions (mm): 1000, 2020, 3000

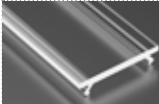
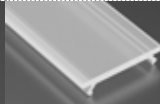

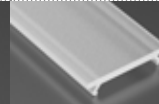
	BIAŁY (lakierowany) white (lacquered)	CZARNY (lakierowany) black (lacquered)	SREBRNY (anodowany) silver (anodized)	SUROWY raw
Kolory profili Profile colors				
1,0 m	10-0951-10	10-0965-10	10-0974-10	10-0980-10
2,02 m	10-0951-20	10-0965-20	10-0974-20	10-0980-20
3,0 m	10-0951-30	10-0965-30	10-0974-30	10-0980-30
Szerokość taśmy LED (mm) LED strip width (mm)				do 12 up to 12

Klosze (PVC/PMMA/PC) / Covers

Wymiary [mm] / Dimensions (mm): 1000, 2020, 3000

TRANSPARENTNY transparent	MROŻONY frozen	MLECZNY milky	FROSTED MLECZNY milky frosted	CZARNY PMMA black PMMA	LENS 15 lens 15	LENS 30 lens 30
BASIC						
						
1 m/PMMA 11-2350-10	1 m/PMMA 11-2302-10	1 m/PMMA 11-2251-10	1 m/PMMA 11-2406-10	1 m/PMMA 11-2017-10	1 m/PMMA 11-2060-10	1 m/PMMA 11-2080-10
1 m/PC 11-3013-10	1 m/PC 11-3012-10	1 m/PC 11-3011-10				

Zaślepki (tworzywo sztuczne) / End caps (plastic)

Z OTWOREM TRASOWANYM with push-hole			
BIAŁY white	CZARNY black	SREBRNY silver	SZARY gray
BASIC			
			
ABS 12-1041-00	ABS 12-1042-00	ABS lacq. 12-1045-01	ABS 12-1044-00

Dodatki / Accessories

ŁĄCZNIK PROSTY straight connector	ŁĄCZNIK POPRZECZNY KĄTOWY angular transverse connector	ŁĄCZNIK KĄTOWY 90° angular connector 90°	ŁĄCZNIK KĄTOWY 120° angular connector 120°
			
14-3032-02	14-3038-01	14-3030-01	14-3036-01

FALCO
LUMINES



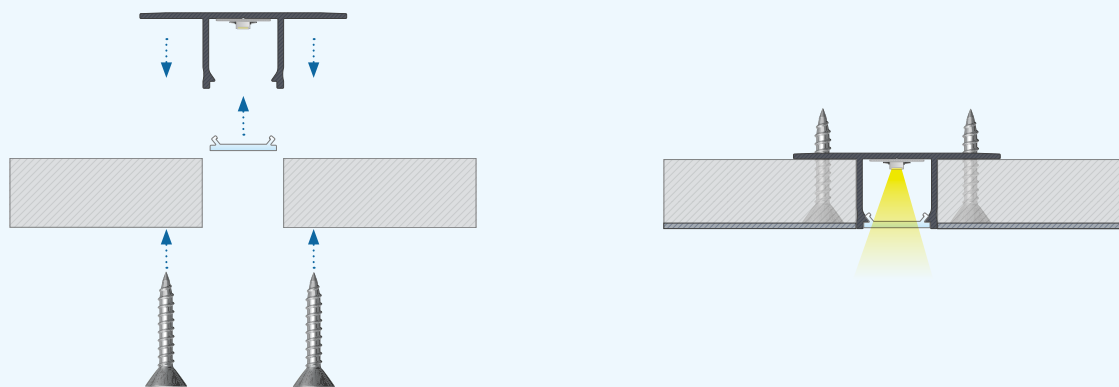

PL
Instrukcja montażu profilu FALCO z kloszem BASIC przy pomocy wkrętów montażowych.

EN
Installation instruction for profile FALCO with a BASIC cover using mounting screws.

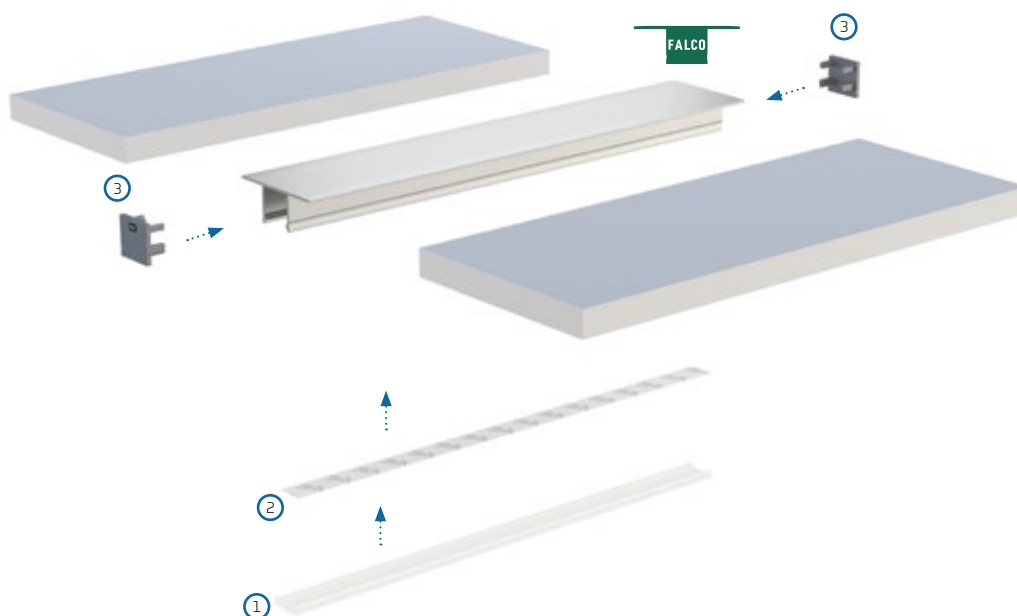

PL
Schemat złożenia elementów systemu oświetleniowego w suficie z wykorzystaniem profilu FALCO oraz (1) klosza BASIC, (2) taśm LED oraz (3) zaślepek z otworem trasowanym.

EN
Assemble scheme for elements of the lighting system in ceiling using profile FALCO and (1) BASIC cover (2), LED strips and (3) end cap with push-hole.

NEW
2023

PLATO

Profil LED / Profile LED

PL
Podwójny profil LED do instalacji między dwoma płytami GK. Pozwala na szybki montaż przy zastosowaniu wkrętów oraz wykończenie gładzią szpachlową bez konieczności użycia siatki montażowej.

EN
Double LED profile for installation between two plasterboard sheets. Allows for fast installation using screws and finishing with plaster without the need for a mounting mesh.

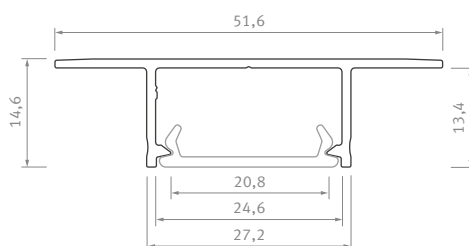

PLATO

Sposoby montażu /
Assembly methods





PLATO

PLATO

Profil LED / Profile LED

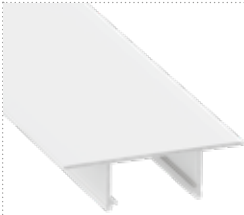
Wymiary [mm] / Dimensions [mm]: 1000, 2020, 3000

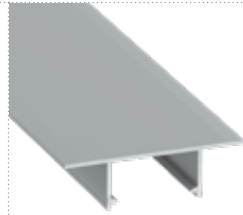
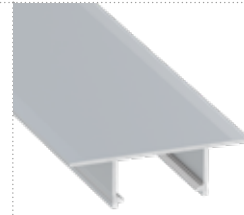
	BIAŁY (lakierowany) white (lacquered)	CZARNY (lakierowany) black (lacquered)	SREBRNY (anodowany) silver (anodized)	SUROWY raw
Kolory profili Profile colors				
1,0 m	10-0871-10	10-0885-10	10-0894-10	10-0900-10
2,02 m	10-0871-20	10-0885-20	10-0894-20	10-0900-20
3,0 m	10-0871-30	10-0885-30	10-0894-30	10-0900-30
Szerokość taśmy LED (mm) LED strip width (mm)	2 x 12			

Klosze (PMMA) / Covers



Wymiary [mm] / Dimensions [mm]: 1000, 2020, 3000

TRANSPARENTNY transparent	MROŻONY frozen	MLECZNY milky	FROSTED MLECZNY milky frosted	CZARNY PMMA black PMMA
DOUBLE				
				
1 m/PMMA 11-2073-10	1 m/PMMA 11-2072-10	1 m/PMMA 11-2071-10	1 m/PMMA 11-2076-10	1 m/PMMA 11-2447-10

Zaślepki (tworzywo sztuczne) / End caps (plastic)

Z OTWOREM TRASOWANYM with push-hole			
BIAŁY white	CZARNY black	SREBRNY silver	SZARY gray
BASIC			
			
ABS 12-1021-01	ABS 12-1022-01	ABS lacq. 12-1125-01	ABS 12-1024-01

Dodatki / Accessories

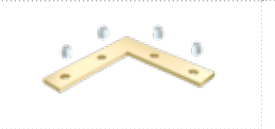
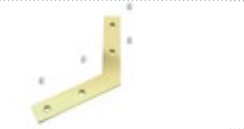
ŁĄCZNIK PROSTY straight connector	ŁĄCZNIK POPRZECZNY KĄTOWY angular transverse connector	ŁĄCZNIK KĄTOWY 90° angular connector 90°	ŁĄCZNIK KĄTOWY 120° angular connector 120°
			
14-3032-02	14-3038-01	14-3030-01	14-3036-01

PLATO
LUMINES



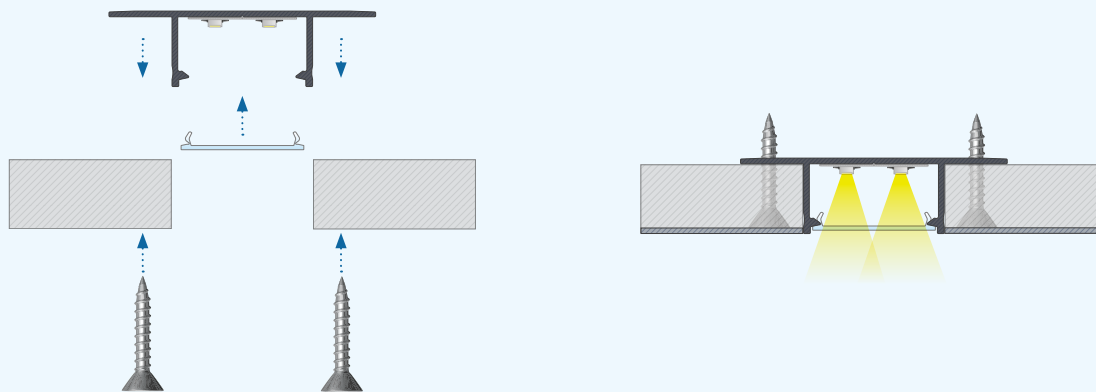

PL
Instrukcja montażu profilu PLATO z kloszem DOUBLE przy pomocy wkrętów montażowych.

EN
Installation instruction for profile PLATO with a DOUBLE cover using mounting screws.

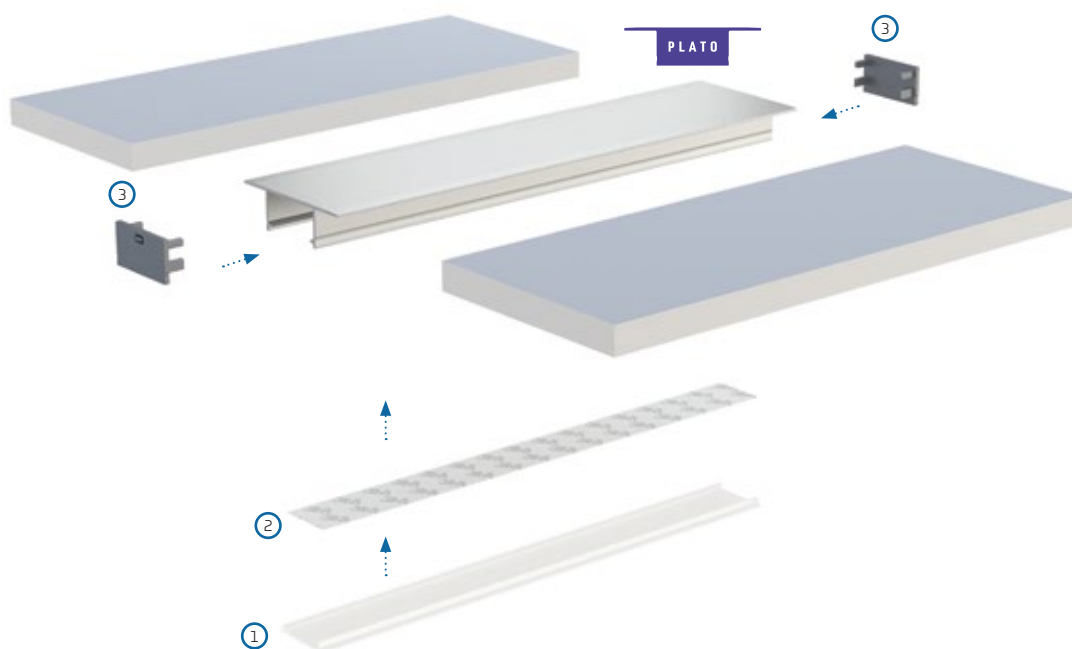

PL
Schemat złożenia elementów systemu oświetleniowego w suficie z wykorzystaniem profilu PLATO oraz (1) klosza DOUBLE, (2) taśm LED oraz (3) zaślepek z otworem trasowanym.

EN
Assemble scheme for elements of the lighting system in ceiling using profile PLATO and (1) DOUBLE cover (2), LED strips and (3) end cap with push-hole.

NEW
2023

GAUDI

Profil LED / Profile LED

PL

Profil LED do montażu i wykończenia gładzi szpachlową zaprojektowany do instalacji jednej taśmy LED. Dzięki uproszczeniu konstrukcji pozwala na szybki i łatwy montaż.

EN

LED profile for installation and finishing with plaster, designed for one LED strip installation. Thanks to its simplified design, it enables quick and easy installation.

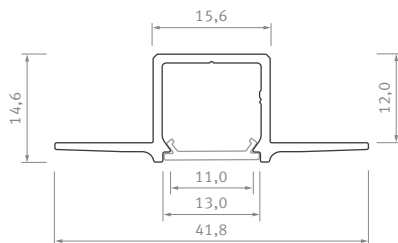

Sposoby montażu /
Assembly methods





GAUDI

GAUDI



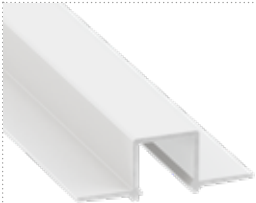
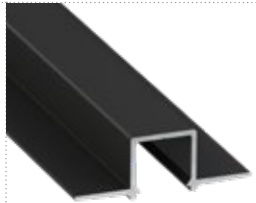
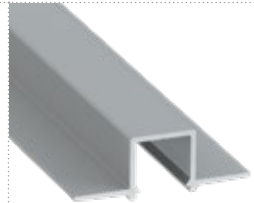



Profil LED / Profile LED

Wymiary [mm] / Dimensions [mm]: 1000, 2020, 3000

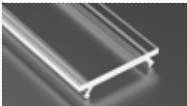

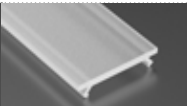

	BIAŁY (lakierowany) white (lacquered)	CZARNY (lakierowany) black (lacquered)	SREBRNY (anodowany) silver (anodized)	SUROWY raw
Kolory profili Profile colors				
1,0 m	10-0951-10	10-0965-10	10-0974-10	10-0980-10
2,02 m	10-0951-20	10-0965-20	10-0974-20	10-0980-20
3,0 m	10-0951-30	10-0965-30	10-0974-30	10-0980-30
Szerokość taśmy LED (mm) LED strip width (mm)	do 12 up to 12			

Klosze (PVC/PMMA/PC) / Covers

Wymiary [mm] / Dimensions [mm]: 1000, 2020, 3000

TRANSPARENTNY transparent	MROŻONY frozen	MLECZNY milky	FROSTED MLECZNY milky frosted	CZARNY PMMA black PMMA	LENS 15 lens 15	LENS 30 lens 30
BASIC						
						
1 m/PMMA 11-2350-10	1 m/PMMA 11-2302-10	1 m/PMMA 11-2251-10	1 m/PMMA 11-2406-10	1 m/PMMA 11-2017-10	1 m/PMMA 11-2060-10	1 m/PMMA 11-2080-10
1 m/PC 11-3013-10	1 m/PC 11-3012-10	1 m/PC 11-3011-10				

Zaślepki (tworzywo sztuczne) / End caps (plastic)

Z OTWOREM with a hole			
BIAŁY white	CZARNY black	SREBRNY silver	SZARY gray
BASIC			
			
ABS 12-1041-00	ABS 12-1042-00	ABS lacq. 12-1045-01	ABS 12-1044-00

GAUDI
LUMINES



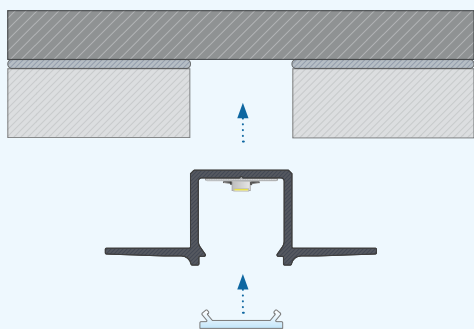

PL
Instrukcja montażu profilu GAUDI z kloszem BASIC.

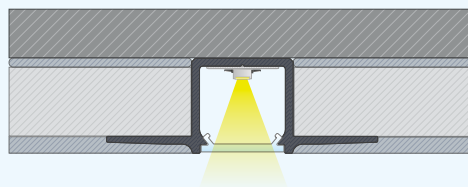

EN
Installation instruction for profile GAUDI with a BASIC cover.

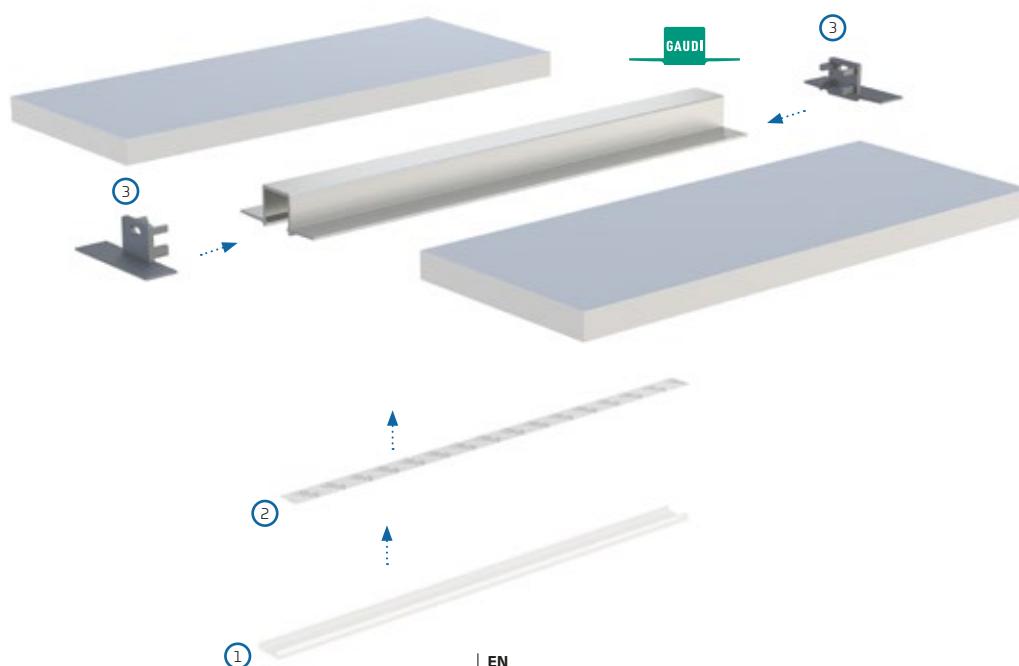

PL
Schemat złożenia elementów systemu oświetleniowego w suficie z wykorzystaniem profilu GAUDI oraz (1) klosza BASIC, (2) taśm LED oraz (3) zaślepek z otworem.

EN
Assemble scheme for elements of the lighting system in ceiling using profile GAUDI and (1) BASIC cover (2), LED strips and (3) end cap with hole.



NEW
2023

HIRO

Profil LED / Profile LED

PL

Podwójny Profil LED do montażu i wykończenia gładzi szpachlową zaprojektowany do instalacji dwóch równoległych taśm LED. Dzięki uproszczeniu konstrukcji pozwala na szybki i łatwy montaż.

EN

Double LED profile for installation and finishing with plaster, designed for two parallel LED strip installations. Thanks to its simplified design, it enables quick and easy installation.

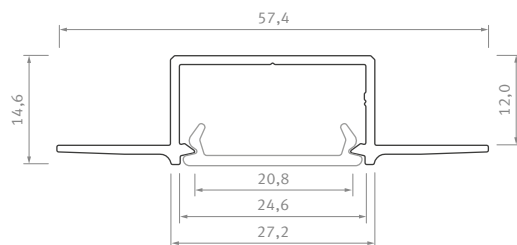

Sposoby montażu /
Assembly methods







HIRO

HIRO

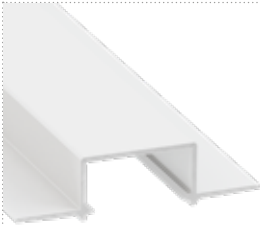
Profil LED / Profile LED

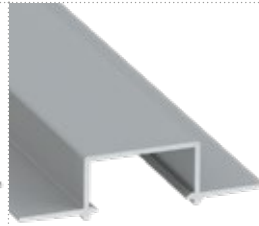
Wymiary [mm] / Dimensions [mm]: 1000, 2020, 3000





	BIAŁY (lakierowany) white (lacquered)	CZARNY (lakierowany) black (lacquered)	SREBRNY (anodowany) silver (anodized)	SUROWY raw
Kolory profili Profile colors				
1,0 m	10-0831-10	10-0845-10	10-0854-10	10-0860-10
2,02 m	10-0831-20	10-0845-20	10-0854-20	10-0860-20
3,0 m	10-0831-30	10-0845-30	10-0854-30	10-0860-30
Szerokość taśmy LED (mm) LED strip width (mm)	2 x 12			

Klosze (PMMA) / Covers

Wymiary [mm] / Dimensions [mm]: 1000, 2020, 3000

TRANSPARENTNY transparent	MROŻONY frozen	MLECZNY milky	FROSTED MLECZNY milky frosted	CZARNY PMMA black PMMA
DOUBLE				
				
1 m/PMMA 11-2073-10	1 m/PMMA 11-2072-10	1 m/PMMA 11-2071-10	1 m/PMMA 11-2076-10	1 m/PMMA 11-2447-10

Zaślepki (tworzywo sztuczne) / End caps (plastic)

Z OTWOREM with a hole			
BIAŁY white	CZARNY black	SREBRNY silver	SZARY gray
BASIC			
			
ABS 12-1011-00	ABS 12-1012-00	ABS lacq. 12-1015-01	ABS 12-1014-00

LUMINES[®]
LIGHTING

HIRO
LUMINES

HIRO
LUMINES



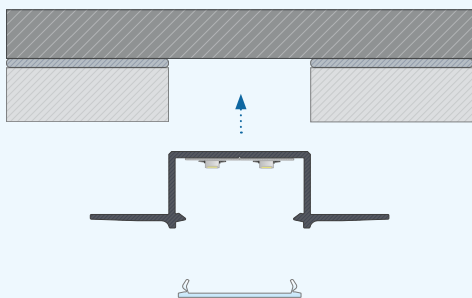

PL
Instrukcja montażu profilu HIRO z kloszem DOUBLE.

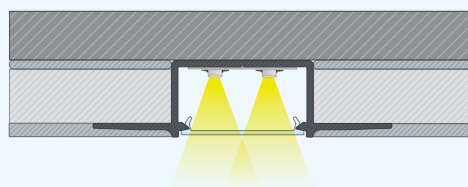

EN
Installation instruction for profile HIRO with a DOUBLE cover.

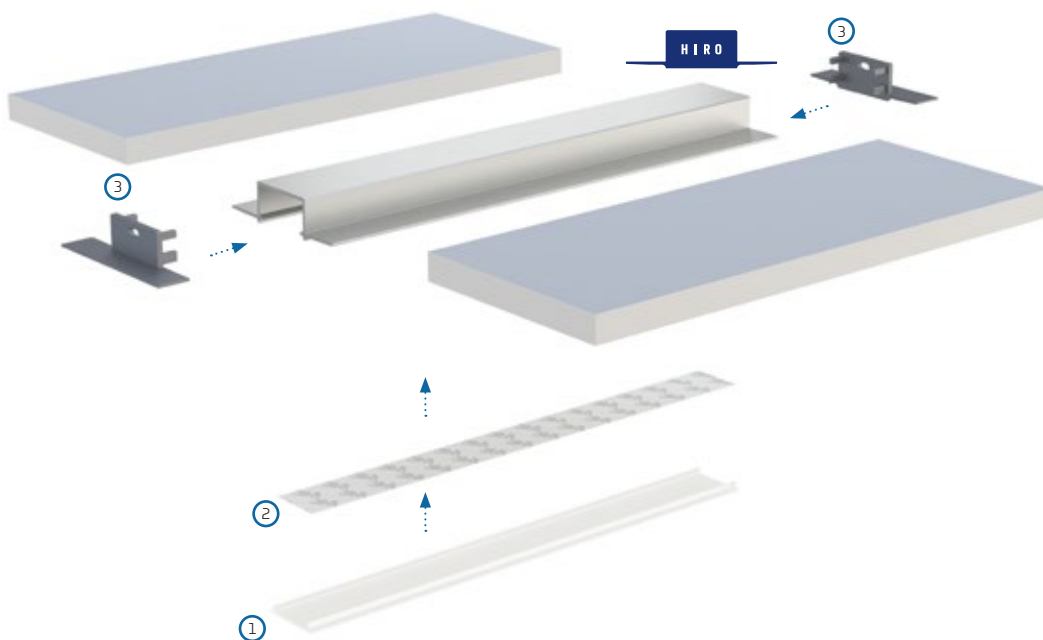

PL
Schemat złożenia elementów systemu oświetleniowego w suficie z wykorzystaniem profilu HIRO oraz (1) klosza DOUBLE, (2) taśm LED oraz (3) zaślepek z otworem.

EN
Assemble scheme for elements of the lighting system in ceiling using profile HIRO and (1) DOUBLE cover (2), LED strips and (3) end cap with hole.

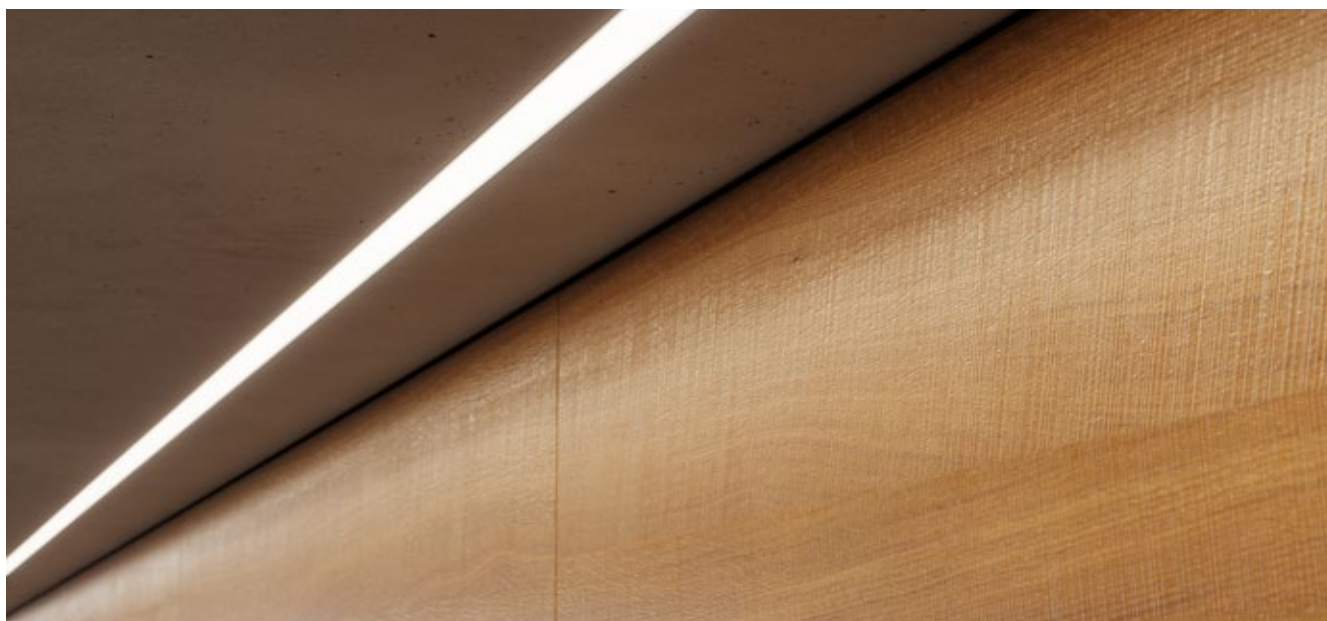

MONO

Profil LED / Profile LED

PL
Niski profil wpuszczany, montowany bezpośrednio na ścianie pomiędzy dwie płyty G-K, z miejscem na jedną taśmę LED. Do stosowania w nowoczesnej architekturze mieszkalnej w budynkach użyteczności publicznej.

EN
Low plaster-in recessed profile, mounted between two plasterboards, with space for one row of a LED strip. For use in modern residential architecture in public utility buildings.

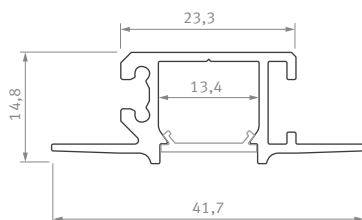

Sposoby montażu /
Assembly methods





MONO







Profil LED / Profile LED

Wymiary [mm] / Dimensions (mm): 1000, 2020, 3000



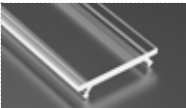

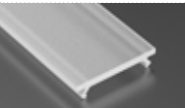







	BIAŁY (lakierowany) white (lacquered)	CZARNY (lakierowany) black (lacquered)	SREBRNY (anodowany) silver (anodized)
Kolory profili Profile colors			
1,0 m	10-0681-10	10-0685-10	10-0684-10
2,02 m	10-0681-20	10-0685-20	10-0684-20
3,0 m	10-0681-30	10-0685-30	10-0684-30
Szerokość taśmy LED (mm) LED strip width (mm)	do 12 up to 12		

Klosze (PVC/PMMA/PC) / Covers

Wymiary [mm] / Dimensions (mm): 1000, 2020, 3000

TRANSPARENTNY transparent	MROŻONY frozen	MLECZNY milky	FROSTED MLECZNY milky frosted	CZARNY PMMA black PMMA
BASIC				
				
1 m/PMMA 11-2350-10 1 m/PC 11-3013-10	1 m/PMMA 11-2302-10 1 m/PC 11-3012-10	1 m/PMMA 11-2251-10 1 m/PC 11-3011-10	1 m/PMMA 11-2406-10	1 m/PMMA 11-2017-10

Zaślepki (aluminium i tworzywo sztuczne) / End caps (aluminum and plastic)

Z OTWOREM with a hole					
BIAŁY white		CZARNY black		SREBRNY / SZARY silver/ gray	
LEWA left	PRAWA right	LEWA left	PRAWA right	LEWA left	PRAWA right
					
ALU 12-1231-10	ALU 12-1241-10	ALU 12-0000-17	ALU 12-0000-18	ALU 12-1235-10	ALU 12-1245-10
					
ABS 12-1081-00		ABS 12-1082-00		ABS lacq. 12-1285-01 ABS 12-1084-00	

Dodatki / Accessories

ŁĄCZNIK PROSTY straight connector	ŁĄCZNIK POPRZECZNY KĄTOWY angular transverse connector	ŁĄCZNIK KĄTOWY 90° angular connector 90°	ŁĄCZNIK KĄTOWY 120° angular connector 120°
			
14-3032-02	14-3038-01	14-3030-01	14-3036-01



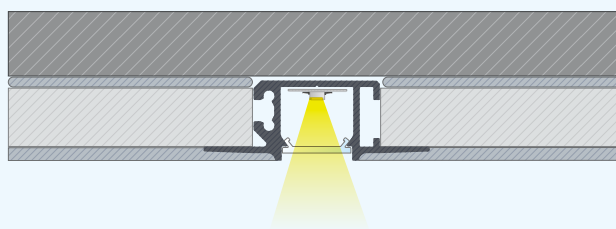
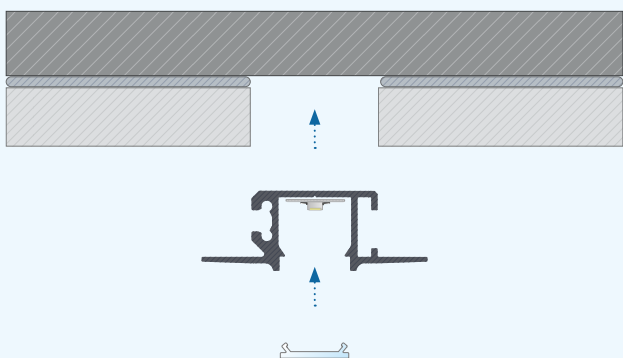

PL

Instrukcja montażu profilu MONO z kloszem BASIC wpuszczonego pomiędzy płytami.

EN

Installation manual for MONO profile with BASIC cover, groove mounted between the two plasterboards.

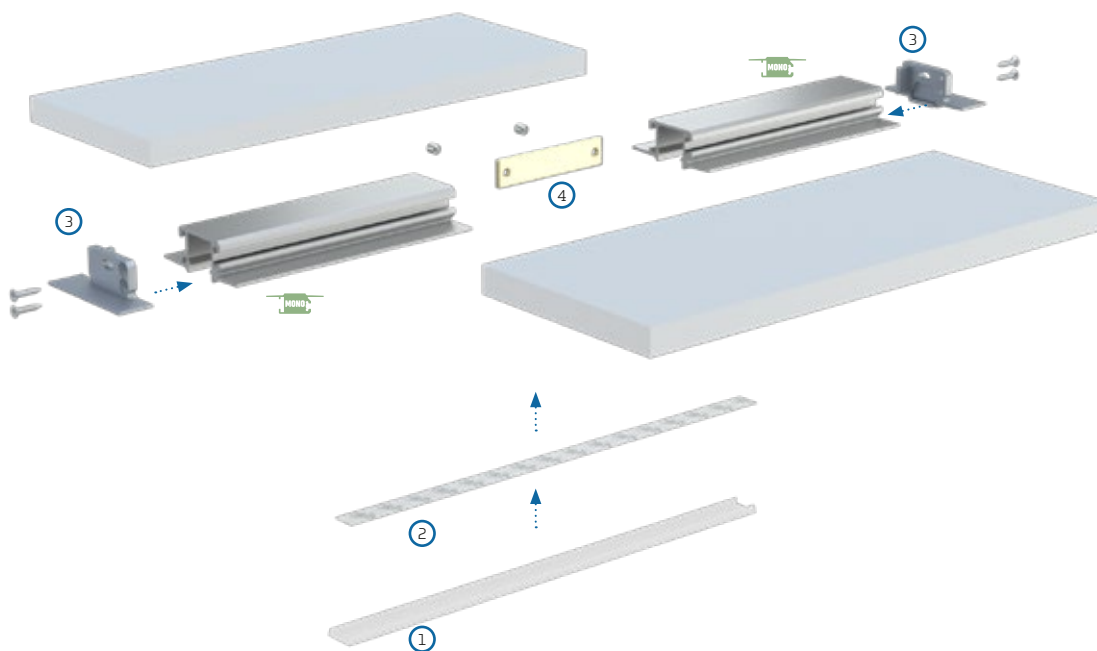

PL

Schemat złożenia elementów systemu oświetleniowego w zabudowie z wykorzystaniem profilu MONO (1) klosza BASIC, (2) taśm LED, (3) zaślepek MONO z otworem, (4) łącznika prostego.

EN

Assembly schematic for the elements of the lighting system using recessed profile MONO (1) BASIC cover, (2) LED strips, (3) MONO end caps with hole, (4) straight connector.

ZATI

Profil LED / Profile LED

PL
Niski profil wpuszczany, montowany bezpośrednio na ścianie pomiędzy dwie płyty G-K, z miejscem na dwie taśmy LED. Do stosowania w nowoczesnej architekturze mieszkalnej w budynkach użyteczności publicznej.

EN
Low recessed profile, mounted between two plasterboards, with space for two rows of LED strips. For use in modern residential architecture in public utility buildings.

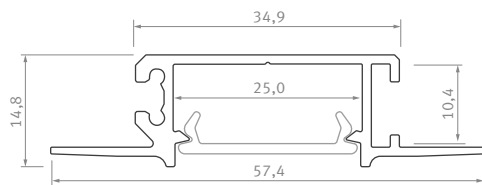

Sposoby montażu /
Assembly methods





ZATI

ZATI

Profil LED / Profile LED

Wymiary [mm] / Dimensions [mm]: 1000, 2020, 3000

	BIAŁY (lakierowany) white (lacquered)	CZARNY (lakierowany) black (lacquered)	SREBRNY (anodowany) silver (anodized)
Kolory profili Profile colors			
1,0 m	10-0591-10	10-0595-10	10-0594-10
2,02 m	10-0591-20	10-0595-20	10-0594-20
3,0 m	10-0591-30	10-0595-30	10-0594-30
Szerokość taśmy LED [mm] LED strip width [mm]	2 × 12		

Klosze (PMMA) / Covers

Wymiary [mm] / Dimensions [mm]: 1000, 2020, 3000

TRANSPARENTNY transparent	MROŻONY frozen	MLECZNY milky	FROSTED MLECZNY milky frosted	CZARNY PMMA black PMMA
DOUBLE				
				
1 m/PMMA 11-2073-10	1 m/PMMA 11-2072-10	1 m/PMMA 11-2071-10	1 m/PMMA 11-2076-10	1 m/PMMA 11-2447-10

Zaślepki (aluminium i tworzywo sztuczne) / End caps (aluminum and plastic)

Z OTWOREM with a hole					
BIAŁY white		CZARNY black		SREBRNY / SZARY silver / gray	
LEWA left	PRAWA right	LEWA left	PRAWA right	LEWA left	PRAWA right
					
ALU 12-0901-10	ALU 12-0911-10	ALU 12-0000-51	ALU 12-0000-52	ALU 12-0905-10	ALU 12-0915-10
					
ABS 12-1071-00		ABS 12-1072-00		ABS lacq, 12-1075-01 ABS 12-1074-00	

Dodatki / Accessories

ŁĄCZNIK PROSTY straight connector	ŁĄCZNIK POPRZECZNY KĄTOWY angular transverse connector	ŁĄCZNIK KĄTOWY 90° angular connector 90°	ŁĄCZNIK KĄTOWY 120° angular connector 120°
			
14-3032-02	14-3038-01	14-3030-01	14-3036-01

ZATI
LUMINES



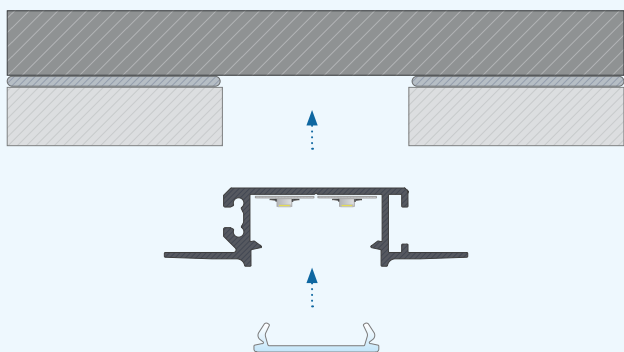

PL
Instrukcja montażu profilu ZATI z kloszem DOUBLE wpuszczonego pomiędzy płytami.

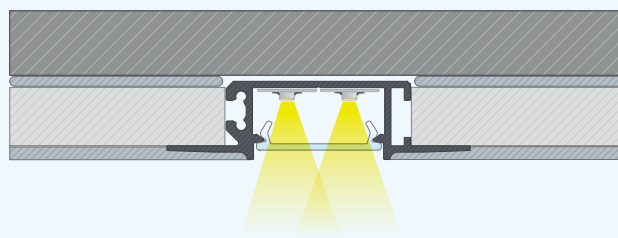

EN
Installation manual for ZATI profile with DOUBLE cover, groove mounted between the two plasterboards.

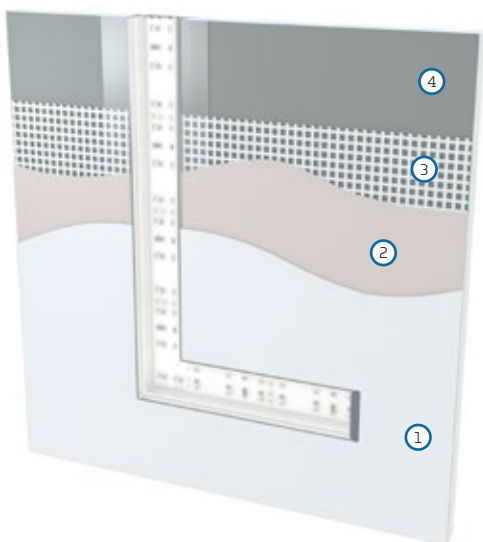

PL
Etapy montażu z wykorzystaniem profilu ZATI w zabudowie bezpo-
średniej.
1. Farba.
2. Gips.
3. Siatka.
4. Pyta karton-gips.

EN
Stages of the assembly using
recessed ZATI profile.
1. Paint.
2. Plaster.
3. Net.
4. Plasterboard.



SUBLI

Profil / Profile

PL
Wysoki profil wpuszczany – do stosowania w zabudowie architektonicznej, budynkach przemysłowych i komercyjnych.

EN
High recessed profile – to be used in the architectural solutions, industrial and commercial facilities.

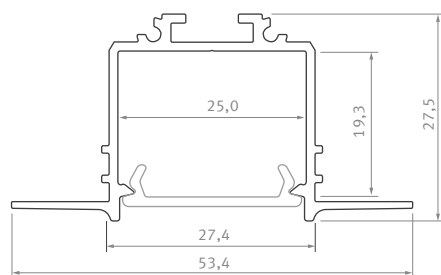

Sposoby montażu /
Assembly methods





SUBLI

SUBLI





Profil LED / Profile LED

Wymiary [mm] / Dimensions [mm]: 1000, 2020, 3000

	BIAŁY (lakierowany) white (lacquered)	CZARNY (lakierowany) black (lacquered)	SREBRNY (anodowany) silver (anodized)
Kolory profili Profile colors			
1,0 m	10-0551-10	10-0555-10	10-0554-10
2,02 m	10-0551-20	10-0555-20	10-0554-20
3,0 m	10-0551-30	10-0555-30	10-0554-30
Szerokość taśmy LED [mm] LED strip width [mm]	2 × 12		

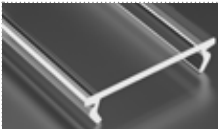
Klosze (PMMA) / Covers

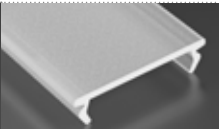
Wymiary [mm] / Dimensions [mm]: 1000, 2020, 3000

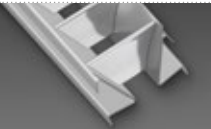
TRANSPARENTNY transparent	MROŻONY frozen	MLECZNY milky	FROSTED MLECZNY milky frosted	CZARNY PMMA black PMMA	SREBRNY silver
DOUBLE					RASTER DOUBLE
					
1 m/PMMA 11-2073-10	1 m/PMMA 11-2072-10	1 m/PMMA 11-2071-10	1 m/PMMA 11-2076-10	1 m/PMMA 11-2447-10	1 m/ 14-0000-48

Zaślepki (aluminium) / End caps (aluminum)

Z OTWOREM with a hole		
BIAŁY white	CZARNY black	SREBRNY silver
		
ALU 12-0661-10	ALU 12-0662-10	ALU 12-0665-10

Dodatki / Accessories

ŁĄCZNIK PROSTY straight connector	ŁĄCZNIK POPRZECZNY KĄTOWY angular transverse connector	ŁĄCZNIK KĄTOWY 90° angular connector 90°	ŁĄCZNIK KĄTOWY 120° angular connector 120°	SPRĘŻYNY MONTAŻOWE mounting springs
				
14-3032-02	14-3038-01	14-3030-01	14-3036-01	14-5001-00

LUMINES[®]
LIGHTING

SUBLI
LUMINES
LIGHTING



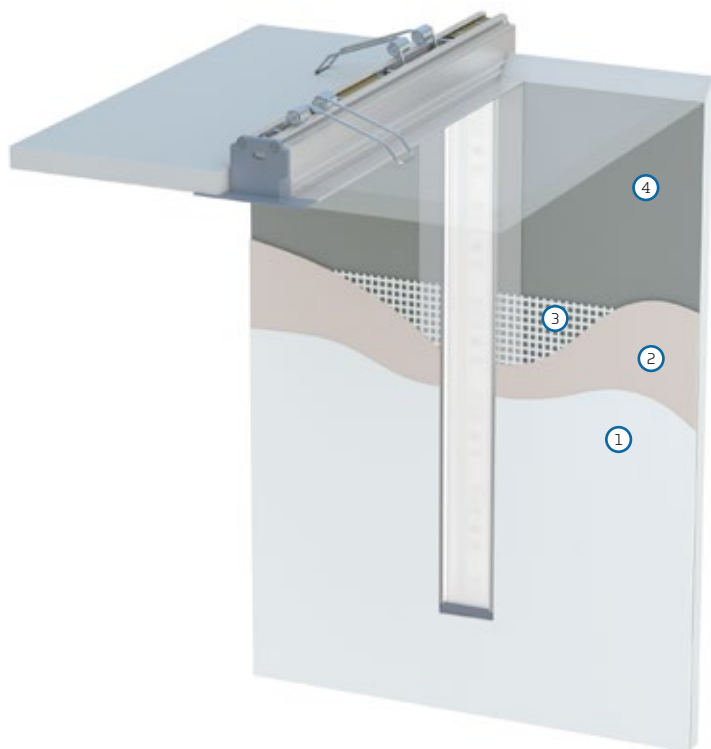

PL

Etapy montażu z wykorzystaniem profilu SUBLI w zabudowie bezpośredniej.

1. Farba.
2. Gips.
3. Siatka.
4. Pyta karton-gips.

EN

Stages of the assembly using recessed SUBLI profile.

1. Paint.
2. Plaster.
3. Net.
4. Plasterboard.



SORGA

Profil LED / Profile LED

PL
Szeroki profil wpuszczany – do stosowania w pomieszczeniach użyteczności publicznej i budynkach przemysłowych.

EN
Wide recessed profile – to be used in public utility premises and industrial facilities.

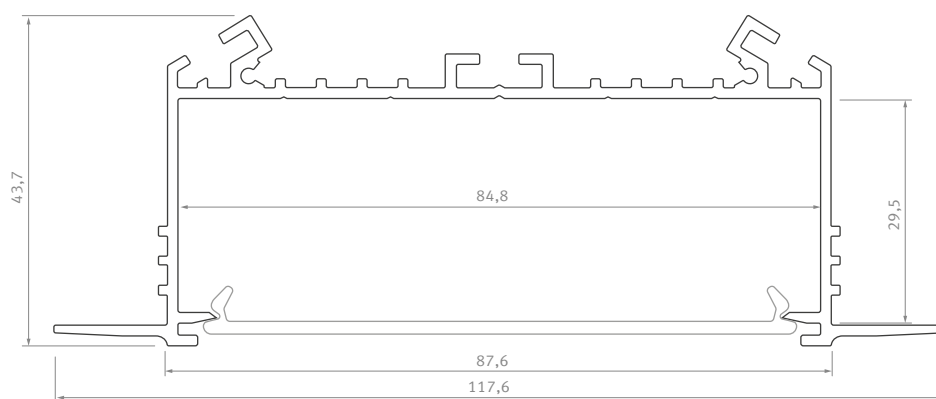

Sposoby montażu /
Assembly methods





SORGA

SORGA



Profil LED / Profile LED

Wymiary [mm] / Dimensions (mm): 1000, 2020, 3000

	BIAŁY (lakierowany) white (lacquered)	CZARNY (lakierowany) black (lacquered)	SREBRNY (anodowany) silver (anodized)
Kolory profili Profile colors			
1,0 m	10-0531-10	10-0765-10	10-0534-10
2,02 m	10-0531-20	10-0765-20	10-0534-20
3,0 m	10-0531-30	10-0765-30	10-0534-30
Szerokość taśmy LED (mm) LED strip width (mm)	6 × 12		

Klosze (PMMA) / Covers

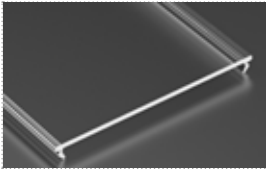
Wymiary [mm] / Dimensions (mm): 1000, 2020, 3000

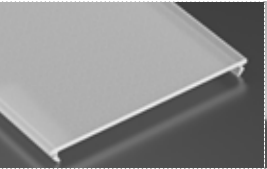
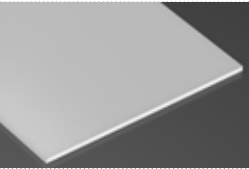
TRANSPARENTNY transparent	MLECZNY milky	FROSTED MLECZNY milky frosted	MLECZNY milky
SUPER WIDE		SUPER WIDE PLEXI	
			
1 m/PMMA 11-2093-10	1 m/PMMA 11-2091-10	1 m/PMMA 11-2096-10	1 m/PLEXI 11-3091-10

Zaślepki (aluminium) / End caps (aluminum)

Z OTWOREM with a hole		
BIAŁY white	CZARNY black	SREBRNY silver
		
ALU 12-0651-10	ALU 12-0652-10	ALU 12-0655-10

Dodatki / Accessories

ŁĄCZNIK PROSTY straight connector	ŁĄCZNIK POPRZECZNY KĄTOWY angular transverse connector	ŁĄCZNIK KĄTOWY 90° angular connector 90°	ŁĄCZNIK KĄTOWY 120° angular connector 120°	SPRĘŻYNY MONTAŻOWE mounting springs
				
14-3032-02	14-3038-01	14-3030-01	14-3036-01	14-5001-00

SORGA
LUMINES



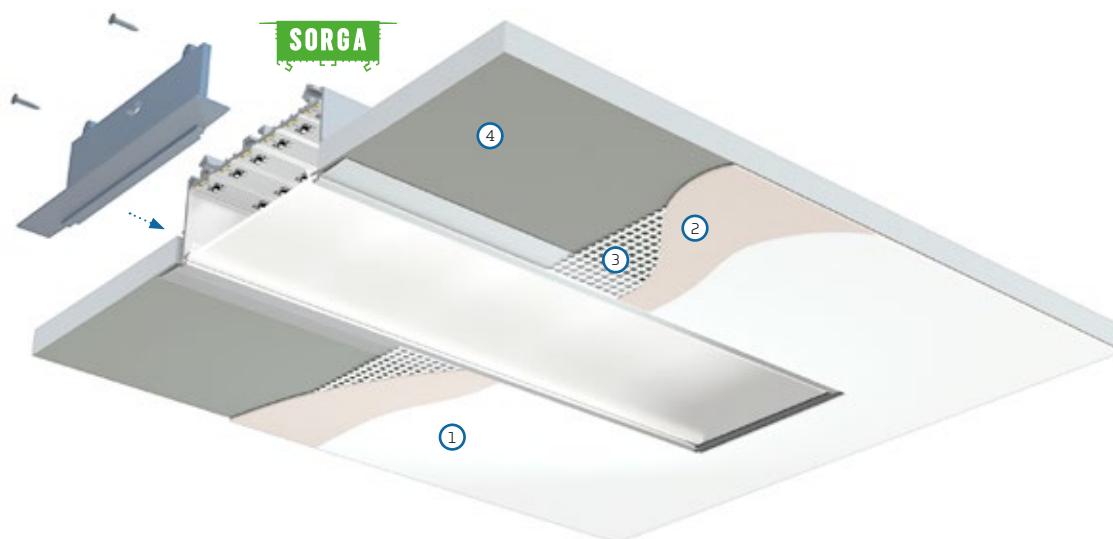

PL

Etapy montażu z wykorzystaniem profilu SORGA w zabudowie bezpośredniej.

1. Farba.
2. Gips.
3. Siatka.
4. Pyta karton-gips.

EN

Stages of the assembly using recessed SORGA profile.

1. Paint.
2. Plaster.
3. Net.
4. Plasterboard.

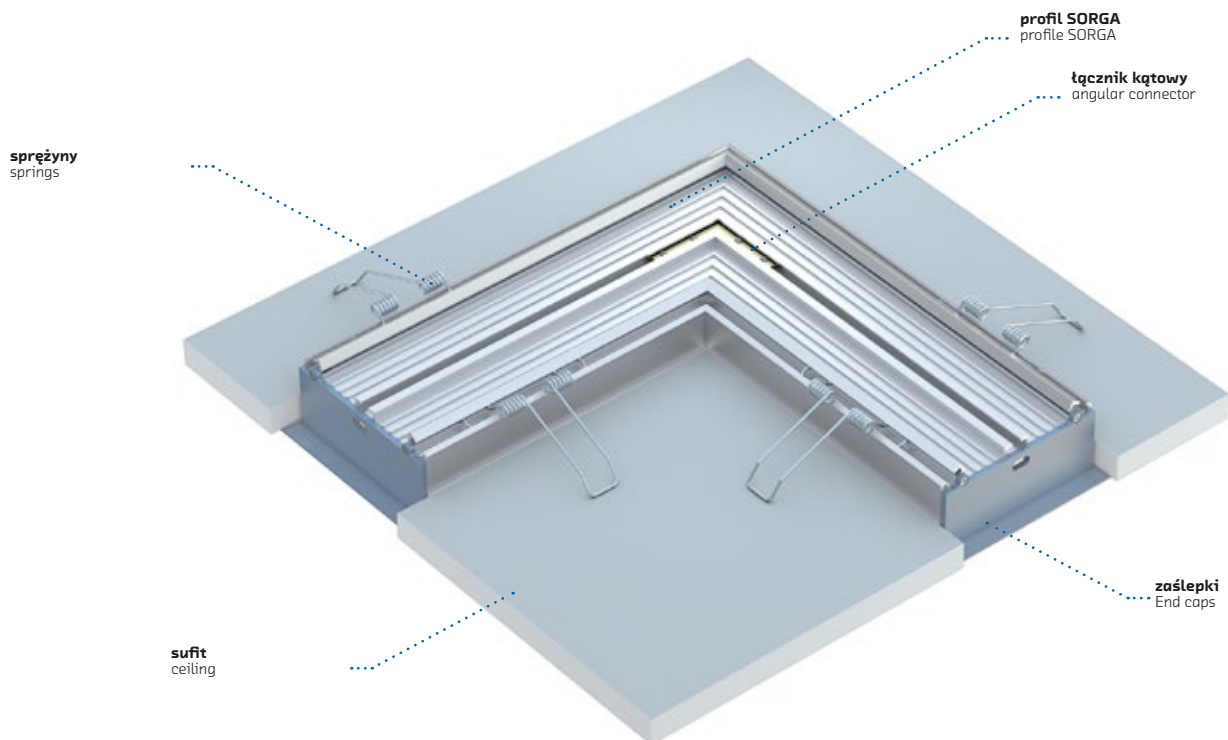

PL

Efekt końcowy montażu systemu profilu SORGA z kloszem SUPER WIDE przy pomocy sprężyn montażowych oraz łącznika kąтового w rzucie izometrycznym od góry.

EN

End result of the assembly of SORGA profile with SUPER WIDE cover using mounting springs and angular connector in isometric view from the top.

TIANO

Profil LED / Profile LED

PL
Profil wpuszczany przypodłogowy / przyschodowy – do oświetlenia pomieszczeń mieszkalnych i budynków komercyjnych.

EN
Indoor walkway lighting recessed profile for lighting residential compartments and commercial facilities.

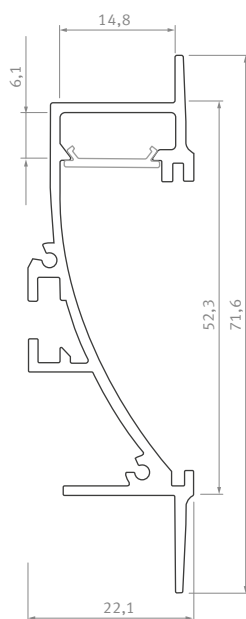

Sposoby montażu /
Assembly methods

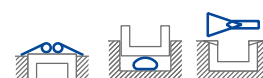

TIANO

Profil LED / Profile LED

Wymiary [mm] / Dimensions [mm]: 1000, 2020, 3000

	BIAŁY (lakierowany) white (lacquered)	CZARNY (lakierowany) black (lacquered)	SREBRNY (anodowany) silver (anodized)
Kolory profili Profile colors			
1,0 m	10-0561-10	10-0555-10	10-0564-10
2,02 m	10-0561-20	10-0815-20	10-0564-20
3,0 m	10-0561-30	10-0815-30	10-0564-30
Szerokość taśmy LED [mm] LED strip width [mm]	do 12 up to 12		

Klosze (PVC/PMMA/PC) / Covers

Wymiary [mm] / Dimensions [mm]: 1000, 2020, 3000

TRANSPARENTNY transparent	MROŻONY frozen	MLECZNY milky	FROSTED MLECZNY milky frosted	CZARNY PMMA black PMMA	MLECZNY milky
BASIC			TIANO PLEXI		
1 m/PMMA 11-2350-10 1 m/PC 11-3013-10	1 m/PMMA 11-2302-10 1 m/PC 11-3012-10	1 m/PMMA 11-2251-10 1 m/PC 11-3011-10	1 m/PMMA 11-2406-10	1 m/PMMA 11-2017-10	1 m/PLEXI 11-3111-10

Zaślepki (aluminium) / End caps (aluminium)

Z OTWOREM with a hole						BEZ OTWORU without a hole					
BIAŁY white		CZARNY black		SREBRNY silver		BIAŁY white		CZARNY black		SREBRNY silver	
LEWA left	PRAWA right	LEWA left	PRAWA right	LEWA left	PRAWA right	LEWA left	PRAWA right	LEWA left	PRAWA right	LEWA left	PRAWA right
ALU 12-0831-10	ALU 12-0841-11	ALU 12-0822-10	ALU 12-0802-10	ALU 12-0835-10	ALU 12-0845-10	ALU 12-0831-11	ALU 12-0841-10	ALU 12-0842-11	ALU 12-0842-10	ALU 12-0835-11	ALU 12-0845-11
DO ZABUDOWY for gypsum finish											
LEWA left	PRAWA right	LEWA left	PRAWA right	LEWA left	PRAWA right						
ALU 12-0811-10	ALU 12-0821-10	ALU 12-0812-10	ALU 12-0832-10	ALU 12-0815-10	ALU 12-0825-10						

Dodatki / Accessories

ŁĄCZNIK PROSTY straight connector	ŁĄCZNIK POPRZECZNY KĄTOWY angular transverse connector	ŁĄCZNIK KĄTOWY 90° angular connector 90°	ŁĄCZNIK KĄTOWY 120° angular connector 120°	SPRĘŻYNY MONTAŻOWE mounting springs
14-3032-02	14-3038-01	14-3030-01	14-3036-01	14-5001-00

LUMINES[®]
LIGHTING



TIANO
LUMINES

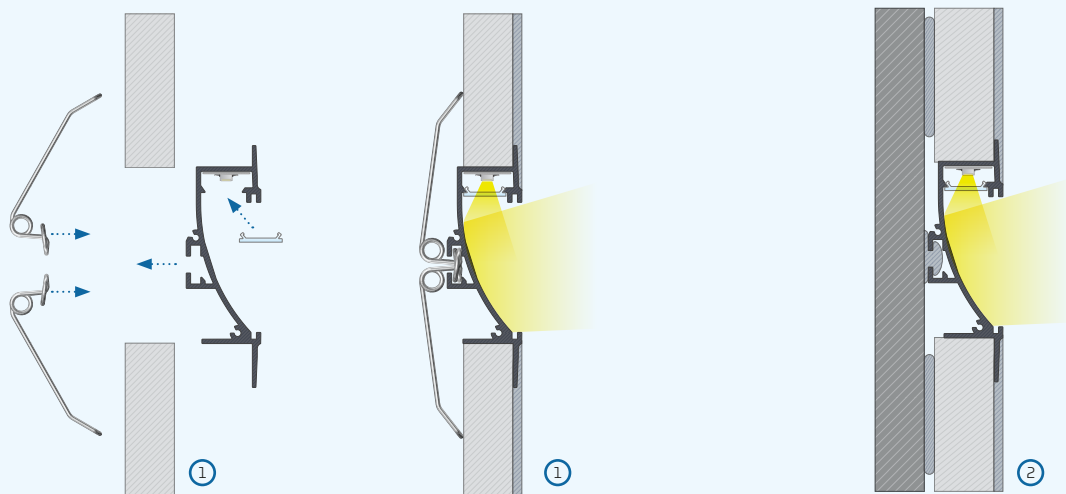

PL
Instrukcja montażu profilu przyподtowego TIANO z kloszem BASIC za pomocą [1] sprężyn montażowych lub [2] z wykorzystaniem kleju montażowego.

EN
Installation manual for recessed TIANO profile with BASIC cover, [1] using mounting springs or with [2] mounting glue.

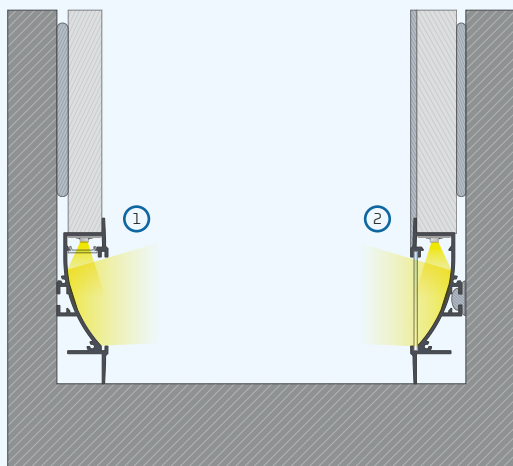

PL
Montaż profilu TIANO [1] z kloszem BASIC, wpuszczonego pomiędzy płytę gipsową a podłogę, [2] z osłoną PLEXI z wykorzystaniem kleju montażowego oraz zagipsowanym fragmentem profilu.

EN
Assembly of the TIANO profile [1] with BASIC cover, recessed between a plasterboard and the floor, [2] with PLEXI cover using mounting glue and with partially plastered finish.

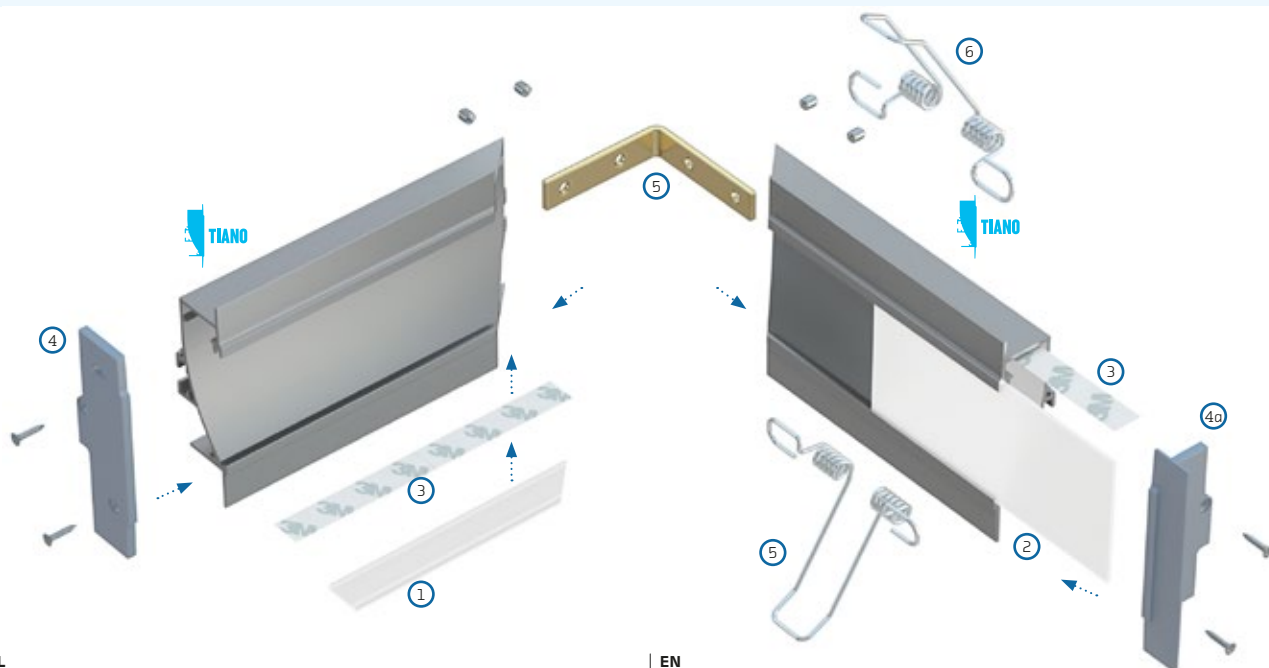

PL
Schemat złożenia elementów systemu oświetleniowego z wykorzystaniem profilu TIANO [1] klosza BASIC, [2] osłony PLEXI TIANO, [3] taśmy LED, [4] zaślepki TIANO z wykończeniem prostym, [4a] zaślepki TIANO z wykończeniem pełnym, [5] łącznika kątownego poprzecznego, [6] sprężyn montażowych.

EN
Assembly scheme for the elements of the lighting system using TIANO profile [1] BASIC cover, [2] PLEXI TIANO cover, [3] LED strip, [4] TIANO end cap with basic finish, [4a] TIANO end cap with full finish, [5] angular transverse connector, [6] mounting springs.

FLARO

Profil LED / Profile LED

PL
Profil wpuszczany przypodłogowy / listwa przypodłogowa – do oświetlenia pomieszczeń mieszkalnych i budynków komercyjnych.

EN
Indoor skirting profile – for lighting residential compartments and commercial facilities.

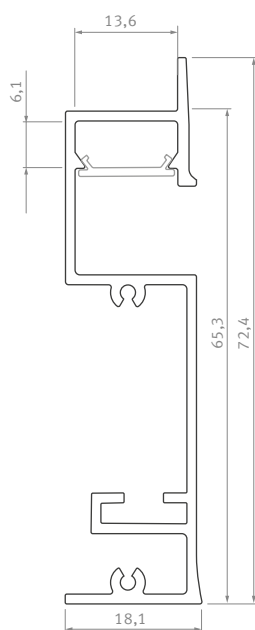

Sposoby montażu /
Assembly methods





FLARO

FLARO



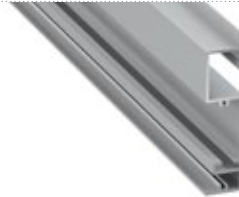

Profil LED / Profile LED

Wymiary [mm] / Dimensions [mm]: 1000, 2020, 3000



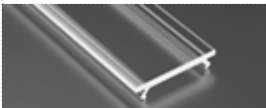



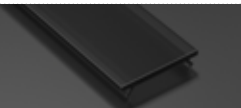







	BIAŁY (lakierowany) white (lacquered)	CZARNY (lakierowany) black (lacquered)	SREBRNY (anodowany) silver (anodized)
Kolory profili Profile colors			
1,0 m	10-0441-10	10-0655-10	10-0444-10
2,02 m	10-0441-20	10-0655-20	10-0444-20
3,0 m	10-0441-30	10-0655-30	10-0444-30
Szerokość taśmy LED [mm] LED strip width [mm]	do 12 up to 12		

Klosze (PVC/PMMA/PC) / Covers



Wymiary [mm] / Dimensions [mm]: 1000, 2020, 3000

TRANSPARENTNY transparent	MROŻONY frozen	MLECZNY milky	FROSTED MLECZNY milky frosted	CZARNY PMMA black PMMA
BASIC				
				
1 m/PMMA 11-2350-10 1 m/PC 11-3013-10	1 m/PMMA 11-2302-10 1 m/PC 11-3012-10	1 m/PMMA 11-2251-10 1 m/PC 11-3011-10	1 m/PMMA 11-2406-10	1 m/PMMA 11-2017-10

Zaślepki (aluminium) / End caps (aluminum)

Z OTWOREM with a hole						BEZ OTWORU without a hole					
BIAŁY white		CZARNY black		SREBRNY silver		BIAŁY white		CZARNY black		SREBRNY silver	
LEWA left	PRAWA right	LEWA left	PRAWA right	LEWA left	PRAWA right	LEWA left	PRAWA right	LEWA left	PRAWA right	LEWA left	PRAWA right
											
ALU 12-0231-10; ALU 12-0241-10; ALU 12-0922-10; ALU 12-0932-10; ALU 12-0255-10; ALU 12-0245-10; ALU 12-0231-11; ALU 12-0241-11; ALU 12-0000-07; ALU 12-0000-08; ALU 12-0255-11; ALU 12-0245-11											
DO ZABUDOWY for gypsum finish											
LEWA left	PRAWA right	LEWA left	PRAWA right	LEWA left	PRAWA right						
											
ALU 12-0211-10; ALU 12-0221-10; ALU 12-0212-10; ALU 12-0222-10; ALU 12-0215-10; ALU 12-0235-10											

Dodatki / Accessories

ŁĄCZNIK PROSTY straight connector	ŁĄCZNIK POPRZECZNY KĄTOWY angular transverse connector	ŁĄCZNIK KĄTOWY 90° angular connector 90°	ŁĄCZNIK KĄTOWY 120° angular connector 120°
			
14-3032-02	14-3038-01	14-3030-01	14-3036-01



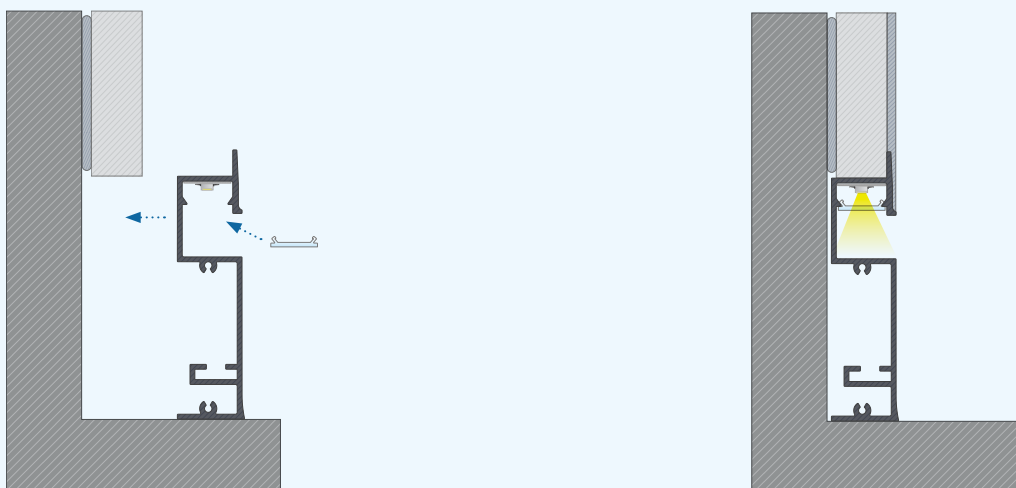

PL
Instrukcja montażu profilu przypodtowego FLARO z kloszem BASIC.

EN
Installation manual for skirting FLARO profile with BASIC cover.

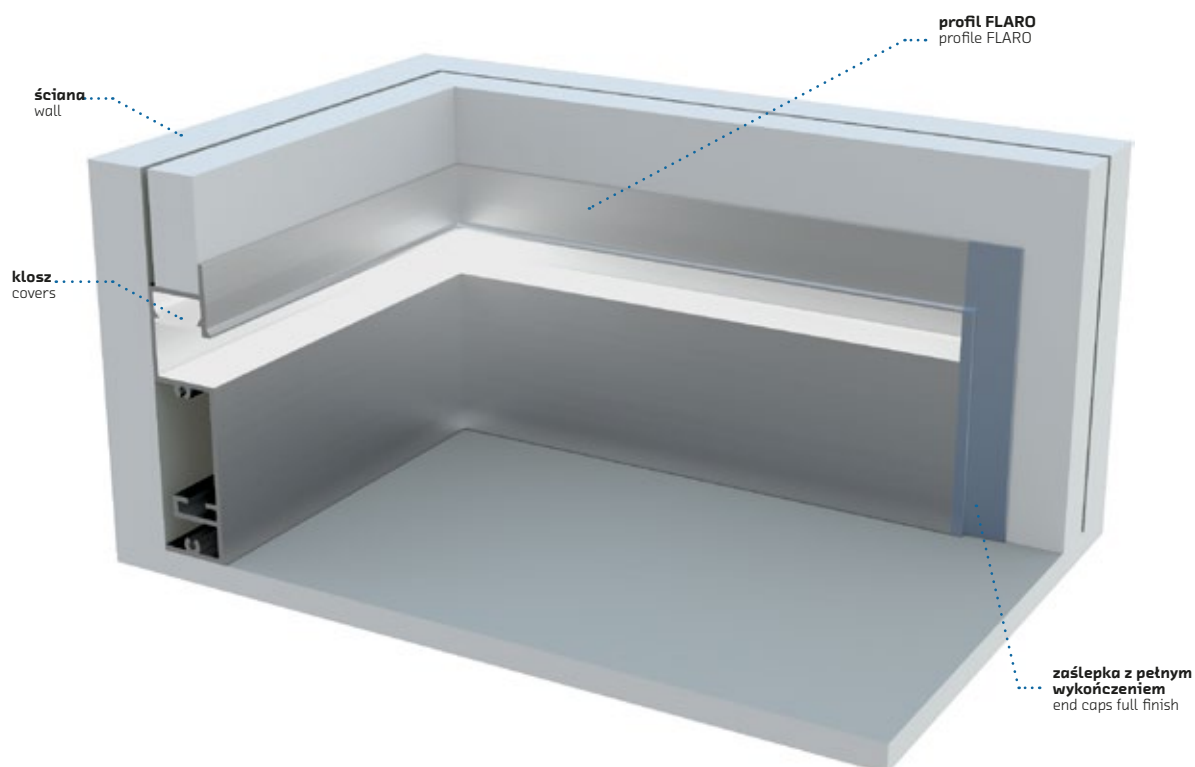

PL
Przykład montażu przypodtowego profilu FLARO pod kątem w miejscu łączenia ścian.

EN
Example of the assembly of skirting FLARO profile at 90 degrees angle.

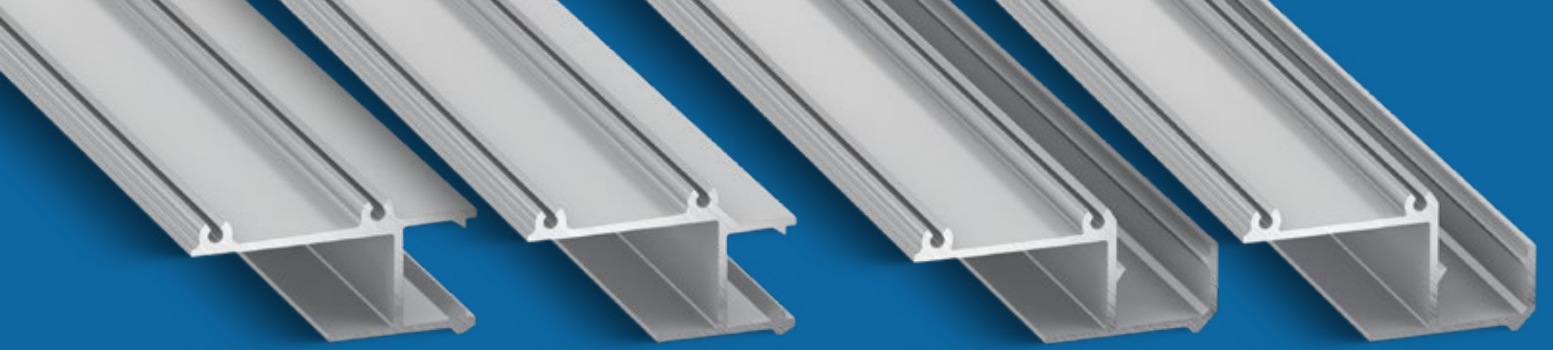

APA / IPA

Profil LED / Profile LED

PL
 Profile ścienna / sufitowe – do oświetlenia wnęk podsufitowych i aranżacji dekoracyjnych.

EN
 Surface profiles – for the decorative and wall lighting or for the cove LED lighting.

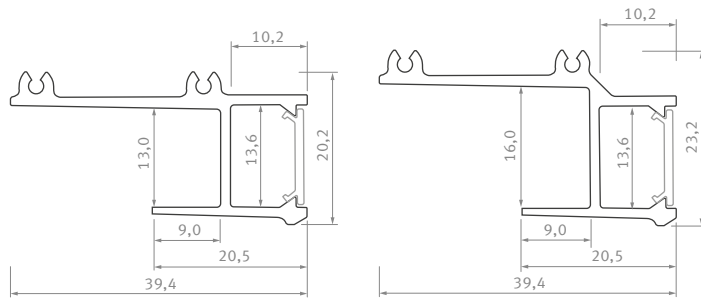

APA12 / APA16

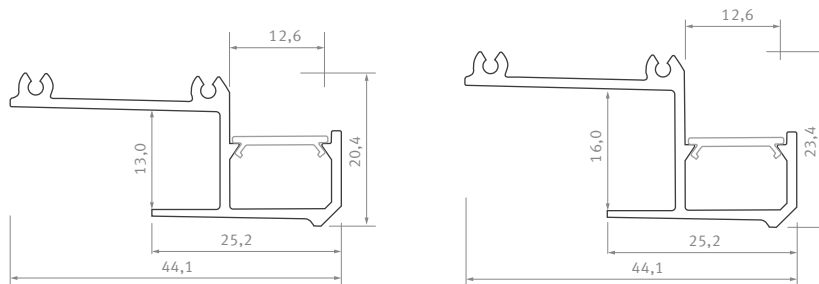

IPA12 / IPA16



Sposoby montażu /
 Assembly methods



APA / IPA



Profil LED / Profile LED

Wymiary [mm] / Dimensions [mm]: 1000, 2020, 3000

	BIAŁY (lakierowany) white (lacquered)	CZARNY (lakierowany) black (lacquered)	SREBRNY (anodowany) silver (anodized)
APA 12			
1,0 m	10-0401-10	10-0401-10	10-0404-10
2,02 m	10-0401-20	10-0401-20	10-0404-20
3,0 m	10-0401-30	10-0401-30	10-0404-30
APA 16			
1,0 m	10-0411-10	10-0411-10	10-0414-10
2,02 m	10-0411-20	10-0411-20	10-0414-20
3,0 m	10-0411-30	10-0411-30	10-0414-30
IPA 12			
1,0 m	10-0481-10	10-0481-10	10-0484-10
2,02 m	10-0481-20	10-0481-20	10-0484-20
3,0 m	10-0481-30	10-0481-30	10-0484-30
IPA 16			
1,0 m	10-0491-10	10-0491-10	10-0494-10
2,02 m	10-0491-20	10-0491-20	10-0494-20
3,0 m	10-0491-30	10-0491-30	10-0494-30
Szerokość taśmy LED (mm) LED strip width (mm)	do 12 up to 12		

Klosze (PVC/PMMA/PC) / Covers

Wymiary [mm] / Dimensions [mm]: 1000, 2020, 3000

TRANSPARENTNY transparent	MROŻONY frozen	MLECZNY milky	FROSTED MLECZNY milky frosted	CZARNY PMMA black PMMA	LENS 15 lens 15	LENS 30 lens 30
BASIC						
1 m/PMMA 11-2350-10	1 m/PMMA 11-2302-10	1 m/PMMA 11-2251-10	1 m/PMMA 11-2406-10	1 m/PMMA 11-2017-10	1 m/PMMA 11-2060-10	1 m/PMMA 11-2080-10
1 m/PC 11-3013-10	1 m/PC 11-3012-10	1 m/PC 11-3011-10				



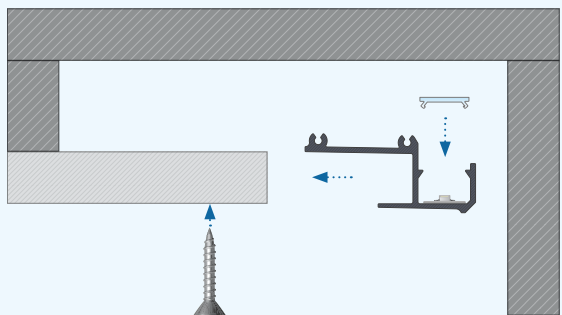

PL
Instrukcja montażu profilu przeznaczonego do montażu sufitowego IPA12/16 z kloszem BASIC.

EN
Instruction for the assembly of profile dedicated for the ceiling lighting installation of IPA 12/16 with BASIC cover.

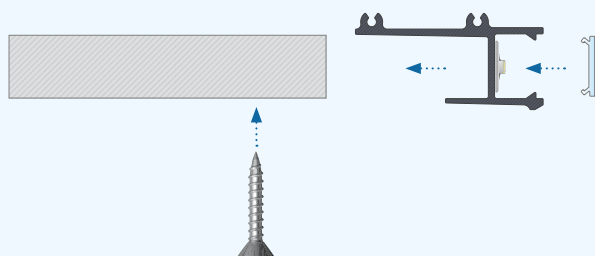
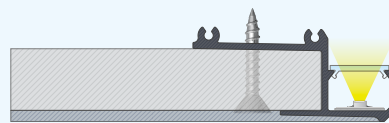

PL
Instrukcja montażu profilu przeznaczonego do montażu ściennego APA12/16 z kloszem BASIC.

EN
Instruction for the assembly of profile dedicated for the ceiling lighting installation of APA 12/16 with BASIC cover.

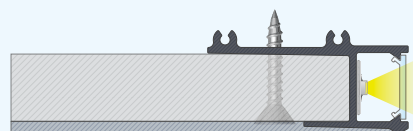

PL
Przykład montażu profilu ściennego APA12 w płycie gipsowej o grubości 12,5 mm pod kątem prostym.

EN
Example of the assembly of ceiling profile APA12 in the plasterboard with the thickness of 12.5 mm at the 90 degrees angle.

PL
Przykład montażu profilu sufitowego IPA16 w płycie gipsowej o grubości 15,8 mm pod kątem prostym.

EN
Example of the assembly of ceiling profile IPA16 in the plasterboard with the thickness of 15.8 mm at the 90 degrees angle.

CONVA / LOGI

Profil LED / Profile LED

PL
Profil napowierzchniowe – do stosowania dekoracyjnego, naściennego oraz przysufitowego.

EN
Surface profiles – for the decorative and wall lighting or for the cove LED lighting.

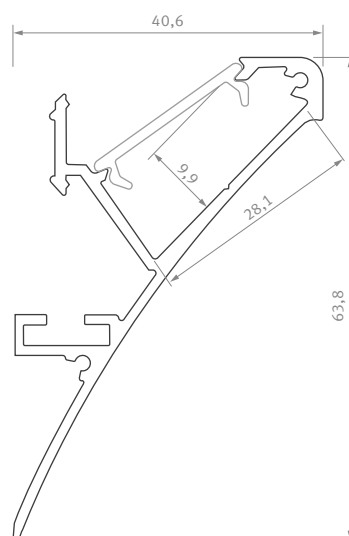
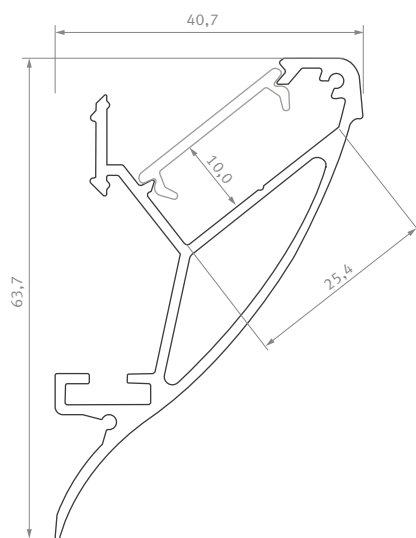

CONVA / LOGI



Sposoby montażu /
Assembly methods

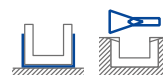



CONVA / LOGI

Profil LED / Profile LED

Wymiary [mm] / Dimensions [mm]: 1000, 2020, 3000

	BIAŁY (lakierowany) white (lacquered)	CZARNY (lakierowany) black (lacquered)	SREBRNY (anodowany) silver (anodized)
CONVA			
1,0 m	10-0421-10	10-0335-10	10-0424-10
2,02 m	10-0421-20	10-0335-20	10-0424-20
3,0 m	10-0421-30	10-0335-30	10-0424-30
LOGI			
1,0 m	10-0501-10	10-0455-10	10-0504-10
2,02 m	10-0501-20	10-0745-20	10-0504-20
3,0 m	10-0501-30	10-0745-30	10-0504-30
Szerokość taśmy LED (mm) LED strip width (mm)	2 × 12		

Klosze (PMMA) / Covers

Wymiary [mm] / Dimensions [mm]: 1000, 2020, 3000

TRANSPARENTNY transparent	MROŻONY frozen	MLECZNY milky	FROSTED MLECZNY milky frosted	CZARNY PMMA black PMMA	SREBRNY silver
DOUBLE			RASTER DOUBLE		
1 m/PMMA 11-2073-10	1 m/PMMA 11-2072-10	1 m/PMMA 11-2071-10	1 m/PMMA 11-2076-10	1 m/PMMA 11-2447-10	1m/ 14-0000-48

Zaślepki (aluminium) / End caps (aluminium)

Z OTWOREM with a hole						BEZ OTWORU without a hole					
BIAŁY white		CZARNY black		SREBRNY silver		BIAŁY white		CZARNY black		SREBRNY silver	
CONVA											
LEWA left	PRAWA right	LEWA left	PRAWA right	LEWA left	PRAWA right	LEWA left	PRAWA right	LEWA left	PRAWA right	LEWA left	PRAWA right
ALU 12-0151-10	ALU 12-0161-10	ALU 12-0152-10	ALU 12-0162-10	ALU 12-0155-10	ALU 12-0165-10	ALU 12-0151-11	ALU 12-0161-11	ALU 12-0152-11	ALU 12-0162-11	ALU 12-0155-11	ALU 12-0165-11
LOGI											
LEWA left	PRAWA right	LEWA left	PRAWA right	LEWA left	PRAWA right	LEWA left	PRAWA right	LEWA left	PRAWA right	LEWA left	PRAWA right
ALU 12-0521-10	ALU 12-0531-10	ALU 12-0522-10	ALU 12-0532-10	ALU 12-0525-10	ALU 12-0535-10	ALU 12-0521-11	ALU 12-0531-11	ALU 12-0000-15	ALU 12-0000-16	ALU 12-0525-11	ALU 12-0535-11

Dodatki / Accessories

ŁĄCZNIK PROSTY straight connector	PROFIL MONTAŻOWY SPARO mounting profile SPARO
14-3032-02	1 m/ 10-0544-10

LOGI
LUMINES

CONVA
LUMINES



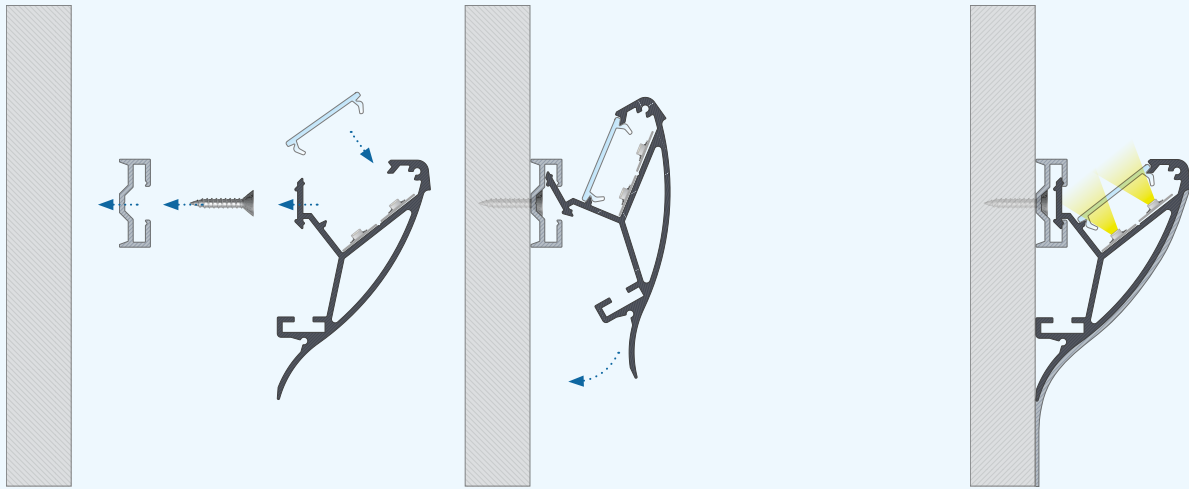

PL
Zasada montażu systemu profilu CONVA z kloszem DOUBLE z wykorzystaniem profilu montażowego SPARO.

EN
Assembly of CONVA profile system with DOUBLE cover using SPARO mounting profile.

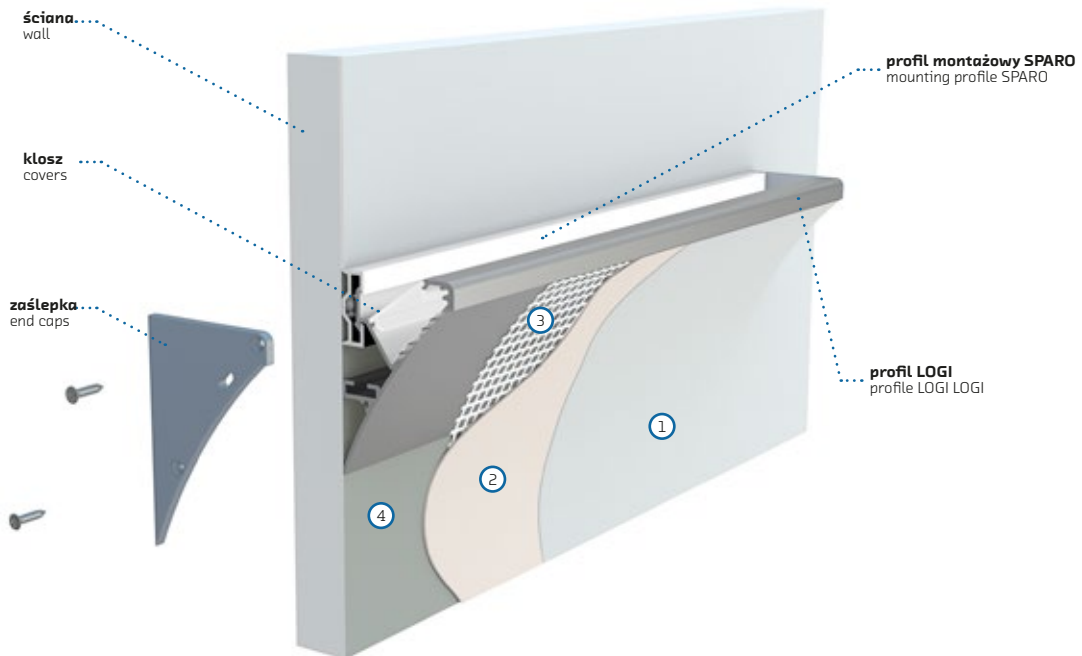

PL
Etapy montażu z wykorzystaniem profilu LOGI.
1. Farba.
2. Gips.
3. Siatka.
4. Pyta karton-gips.

EN
Stages of the assembly using recessed LOGI profile.
1. Paint.
2. Plaster.
3. Net.
4. Plasterboard.

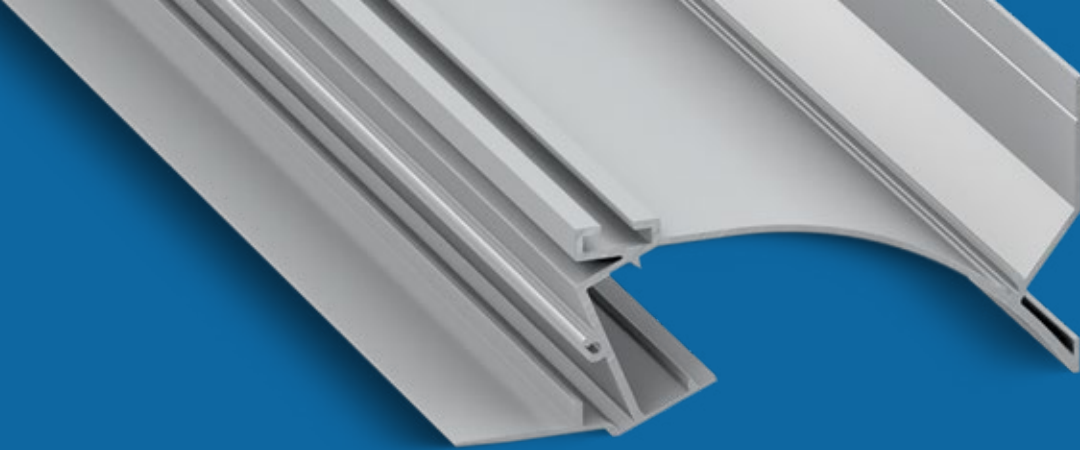

TOPO

Profil LED / Profile LED

PL

Profil między płytowe, konstrukcyjne – do stosowania w sufitach podwieszanych w budownictwie mieszkaniowym.

EN

Recessed drywall system profiles – to be used in suspended ceilings in residential construction.

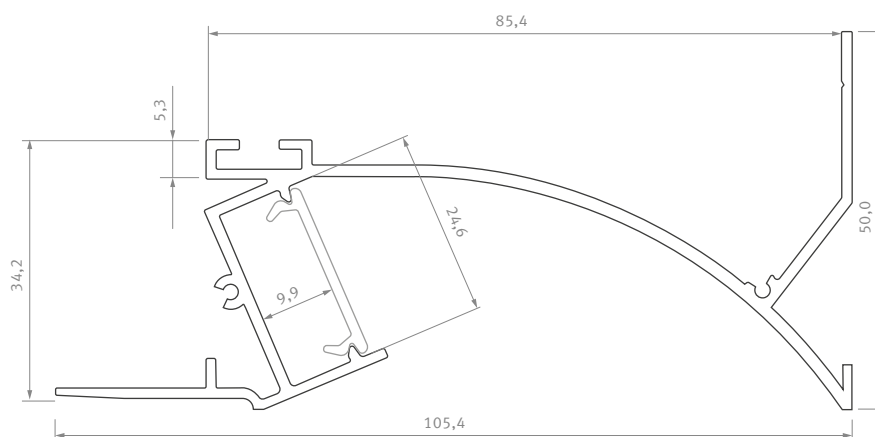

Sposoby montażu /
Assembly methods



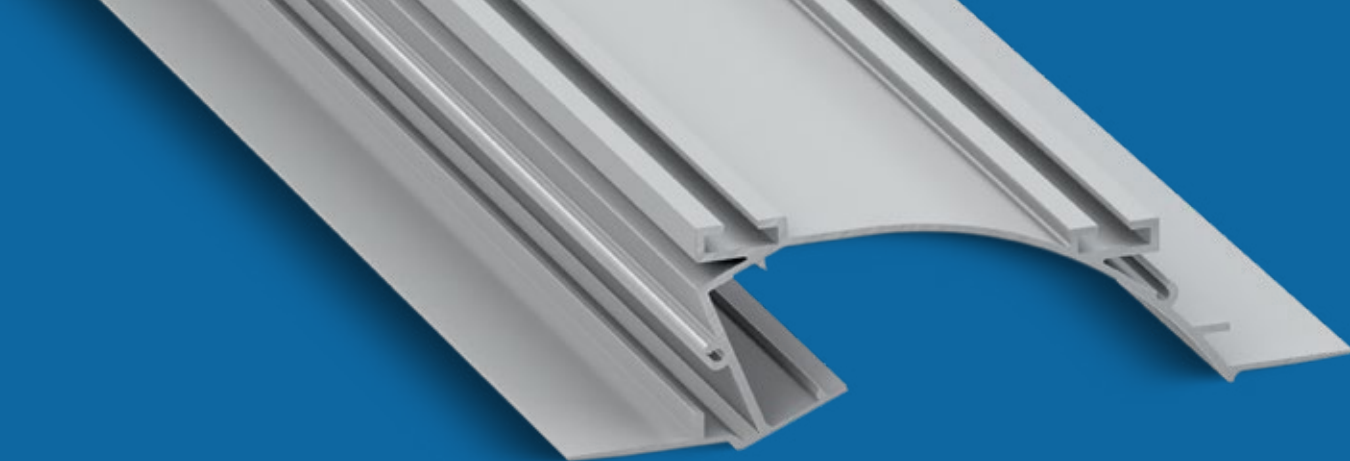

PERO

Profil LED / Profile LED

PL
Profil między płytowe, konstrukcyjne – do stosowania w sufitach podwieszanych w budownictwie mieszkaniowym.

EN
Recessed drywall system profiles – to be used in suspended ceilings in residential construction.

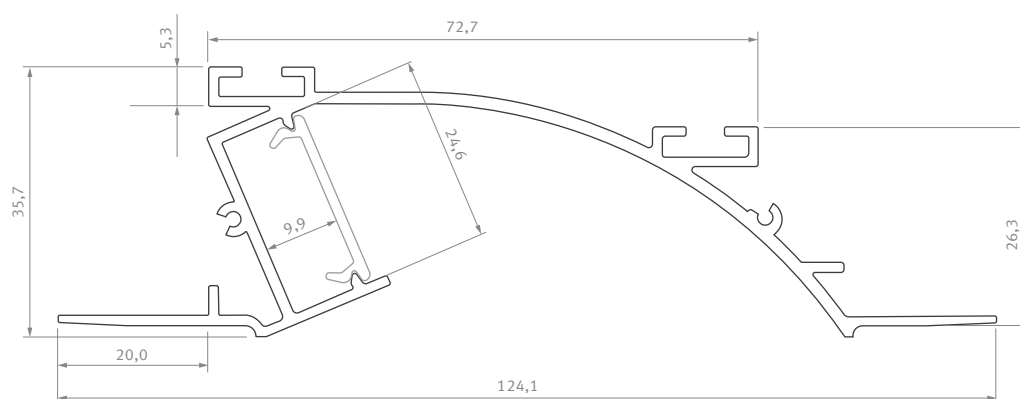

Sposoby montażu /
Assembly methods



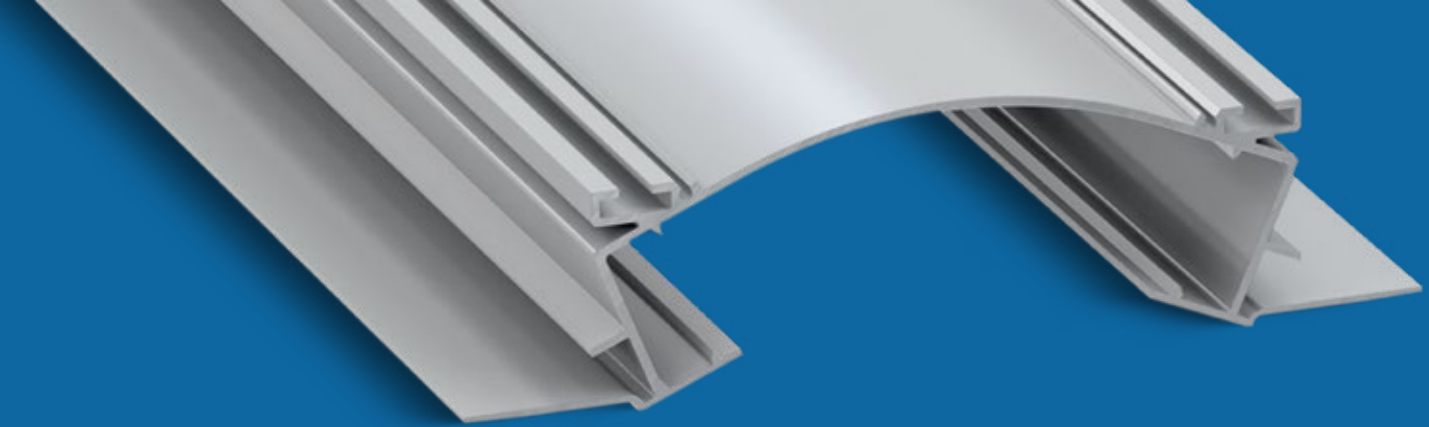

VEDA

Profil LED / Profile LED

PL

Profil między płytowe, konstrukcyjne – do stosowania w sufitach podwieszanych w budownictwie mieszkaniowym.

EN

Recessed drywall system profiles – to be used in suspended ceilings in residential construction.

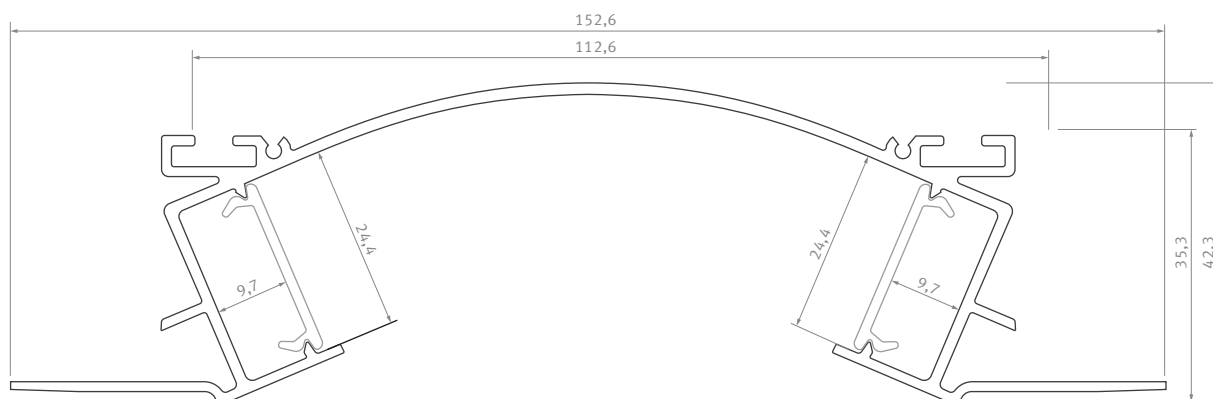

TOPO / PERO / VEDA



Profil LED / Profile LED

Wymiary [mm] / Dimensions [mm]: 1000, 2020, 3000

	BIAŁY (lakierowany) white (lacquered)	CZARNY (lakierowany) black (lacquered)	SREBRNY (anodowany) silver (anodized)
TOPO			
1,0 m	10-0571-10	10-0565-10	10-0574-10
2,02 m	10-0571-20	10-0565-20	10-0574-20
3,0 m	10-0571-30	10-0565-30	10-0574-30
PERO			
1,0 m	10-0511-10	10-0475-10	10-0514-10
2,02 m	10-0511-20	10-0615-20	10-0514-20
3,0 m	10-0511-30	10-0475-30	10-0514-30
VEDA			
1,0 m	10-0581-10	10-0575-10	10-0584-10
2,02 m	10-0581-20	10-0575-20	10-0584-20
3,0 m	10-0581-30	10-0575-30	10-0584-30
Szerokość taśmy LED [mm] LED strip width [mm]	do 12 up to 12		

Klosze (PMMA) / Covers

Wymiary [mm] / Dimensions [mm]: 1000, 2020, 3000

TRANSPARENTNY transparent	MROŻONY frozen	MLECZNY milky	FROSTED MLECZNY milky frosted	CZARNY PMMA black PMMA
DOUBLE				
1 m/PMMA 11-2073-10	1 m/PMMA 11-2072-10	1 m/PMMA 11-2071-10	1 m/PMMA 11-2076-10	1 m/PMMA 11-2447-10

Zaślepki (aluminium) / End caps (aluminum)

Z OTWOREM with a hole					
BIAŁY white	CZARNY black	SREBRNY silver	BIAŁY white	CZARNY black	SREBRNY silver
TOPO			VEDA		
LEWA left	PRAWA right	LEWA left	PRAWA right	LEWA left	PRAWA right
ALU 12-0851-10	ALU 12-0861-10	ALU 12-0862-10	ALU 12-0852-10	ALU 12-0855-10	ALU 12-0865-10
PERO					
LEWA left	PRAWA right	LEWA left	PRAWA right	LEWA left	PRAWA right
ALU 12-0551-10	ALU 12-0561-10	ALU 12-0552-10	ALU 12-0562-10	ALU 12-0555-10	ALU 12-0565-10

Dotatki / Accessories

ŁĄCZNIK PROSTY straight connector	ŁĄCZNIK POPRZECZNY KĄTOWY angular transverse connector	ŁĄCZNIK KĄTOWY 90° angular connector 90°	ŁĄCZNIK KĄTOWY 120° angular connector 120°	SPRĘŻYNY MONTAŻOWE mounting springs
14-3032-02	14-3038-01	14-3030-01	14-3036-01	14-5001-00



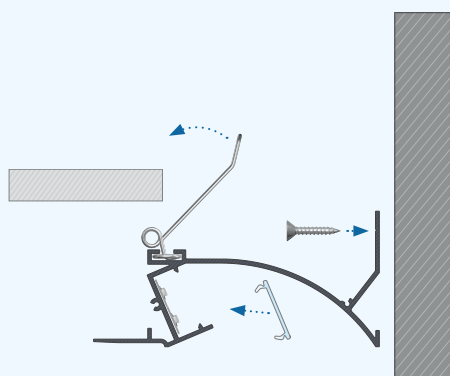

PL
Instrukcja montażu profilu TOPO z kloszem DOUBLE z wykorzystaniem sprężyny montażowej w systemie sufitów podwieszanych.

EN
Instruction of assembly of profile TOPO with DOUBLE cover using mounting spring in suspended ceiling system.

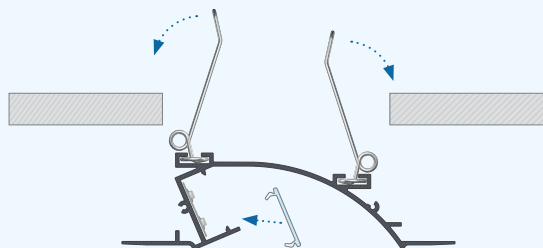
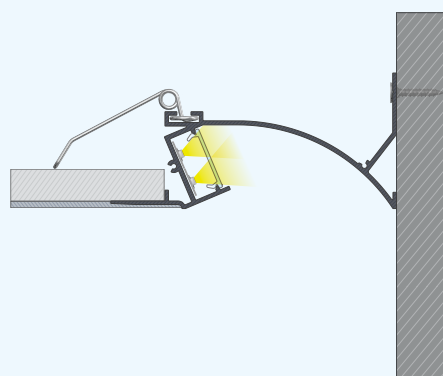

PL
Instrukcja montażu profilu PERO z kloszem DOUBLE z wykorzystaniem sprężyn montażowych w systemie sufitów podwieszanych.

EN
Instruction of assembly of profile PERO with DOUBLE cover using mounting springs in suspended ceiling system.

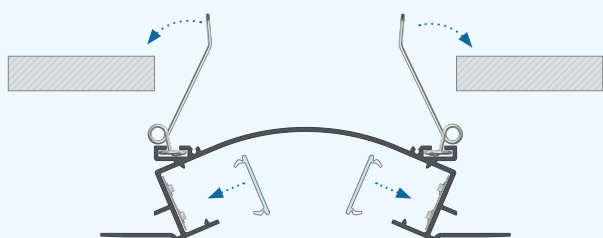
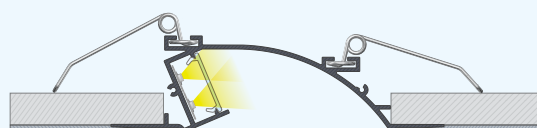

PL
Instrukcja montażu profilu VEDA z kloszami DOUBLE z wykorzystaniem sprężyn montażowych w systemie sufitów podwieszanych.

EN
Instruction of assembly of profile VEDA with DOUBLE cover using mounting springs in suspended ceiling system.



KLOSZE

Covers

PL
Wymiary [mm]:
1000, 2020, 3000

EN
Dimensions [mm]:
1000, 2020, 3000

	TRANSPARENTNY PVC/PC transparent PVC/PC	MROŻONY PVC/PC frozen PVC/PC	MLECZNY PVC milky PVC/PC	TRANSPARENTNY PMMA transparent PMMA	MROŻONY PMMA frozen PMMA	MLECZNY PMMA milky PMMA	FROSTED MLECZNY PMMA milky frosted PMMA PMMA	Prismatic PC	Czarny PMMA black PMMA	SREBRNY silver
BASIC										
HIGH*										
WIDE										
SLIM										
DOUBLE										
TERRA										
SLIM LENS 15										
BASIC LENS 15										
BASIC LENS 30										
SUPER WIDE										
PLEXI TIANO PLEXI SUPER WIDE										
RASTER WIDE										

PRZEPUSZCZALNOŚĆ / TRANSPARENCY*

RODZAJE KŁOSZY type of covers	TEMPERATURA PRACY MATERIAŁU operating temperature of material	BASIC	HIGH	WIDE	SLIM	DOUBLE	TERRA	SLIM LENS 15	BASIC LENS 15	BASIC LENS 30	SUPER WIDE	PLEXI TIANO PLEXI SUPER WIDE
DO PROFILI MEBLOWYCH fits furniture profiles		A / B / C / D / G / H / U / w / y / z	A / D		X / MICO	GEMI		X / MICO	A / B / C / D / G / H / U / w / y / z			
DO PROFILI ARCHITEKTONICZNYCH fits architectural profiles		COSMO / FALCO / FLARO / GAUDI / MONO / RETO / TIANO		SOLIS / INSO / ILEDO	HIRO / PLATO / SILEDA / INSLEDA / INDILEDA UNICO / DOPIOTALIA / INTALIA / ZATI SUBLI / LOGI / CONVA TOPO / PERO / VEDA		TERRA / SCALA / RUNO		COSMO / FALCO / GAUDI / RETO / MONO /		LARGO / INLARGO / SORGA	TIANO LARGO / INLARGO SORGA
TRANSPARENTNY PVC transparent PVC		88%		85%	84%							
MROŻONY PVC frozen PVC	-20°C +65°C	66%		55%	63%							
MLECZNY PVC milky PVC		48%		28%	38%							40%
TRANSPARENTNY PMMA transparent PMMA		95%	95%	94%	95%	93%		96%		92%	93%	
MROŻONY PMMA frozen PMMA	-20°C +70°C	78%	78%	73%	79%	79%						
MLECZNY PMMA milky PMMA		48%	52%	42%	39%	50%						72%
FROSTED MLECZNY PMMA milky frosted PMMA		83%	83%	74%	83%	75%						76%
TRANSPARENTNY PC transparent PC		92%		91%								
MROŻONY PC frozen PC	-50°C +100°C	67%		63%								
MLECZNY PC milky PC		36%		30%			56%					
PRISMATIC PC				87%								
CZARNY PMMA black PMMA	-20°C +70°C	24%	20%		23%	23%						

* Wszystkie badania zostały wykonane w laboratorium fotometrii Lumines. Tolerancja wyniku ± 5%

* All tests were carried out in the Lumines photometry laboratory. Result tolerance ± 5%.

Tabela maksymalnych mocy źródeł światła dopuszczonych do stosowania w profilach LUMINES, przy zachowaniu warunków brzegowych: temperatury 55° C / 131° F oraz 65° C / 149° F na powierzchni profilu
Table of maximum power of light sources approved for use in LUMINES profiles, while keeping the boundary conditions: 55° C / 131° F and 65° C / 149° F temperatures on the profile surface

TEMPERATURA POWIERZCHNI surface temperature	55° C / 131° F	65° C / 149° F
PROFIL profile	Maksymalna moc rozpraszana [W] maximum power dissipated	
A	17	22,2
APA12 / APA16	32,2	43,4
B	17,2	22,5
C	23	31
Claro	55,3	69,9
Conva	50,4	64,4
Cosmo	21	28
D	12	16
Dileda	29,4	39,2
Dopio	44,8	67,2
Dual	20,1	28,7
Dulio	53,3 / 69,9	29,2 / 38,6
Falco	23,8	32
Flaro	42	52,5
G	24,4	32,5
Gaudi	22,8	30,1
Gemi	22,9	30,7
H	23	31
Hiro	32,2	43,7
I10	21	26,6
I6	21	26,6
Iledo	55,5	70,5
inDileda	30,8	40,6
inLargo	100,8	130,2
inSileda	28	37,8
InTalia	44,8	60,2
Inso	61,5	84
IPA12 / IPA16	31,5	42
J	24,2	32,1
Largo	96,6	126
Logi	49	63
Mico	15,4	19,6
Mono	25	34
Pero	81,2	102,2
Plato	33,2	45
Q18 / Q20	23,1	31,5
Reto	23,8	33,6
Runo	19,1	25,8
Scala	51,8	63
Sileda	26,6	36,4
Solis	24,6	33,9
Sorga	67,2	105
Subli	35	46,2
Talia	46,2	63
Terra	17,3	23,5
Tiano	42	52,5
Topo	81,2	102,2
U	24,5	32,8
Unico	42	56
Veda	145,6	173,6
W	23,8	32
X	14	18
Y	24	31,5
Z	15,8	21
Zati	35	47,6
TEMPERATURA OTOCZENIA 25° C / 77° F ambient temperature 25° C / 77° F		

The logo for LUMINES LIGHTING is centered on a blue circular background. The word "LUMINES" is written in a bold, white, sans-serif font, with a registered trademark symbol (®) to its upper right. Below "LUMINES", the word "LIGHTING" is written in a smaller, white, sans-serif font. To the left of the word "LUMINES", there is a stylized white icon consisting of three curved lines that suggest a light beam or a modern lamp design.

LUMINES®
LIGHTING

LUMINES[®]
LIGHTING

www.lumines.pl

